

FIREX®

User Guide

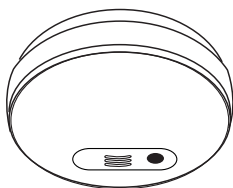

KF10
KF10LL
KF10R
Ionisation

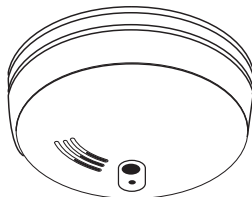

KF20
KF20LL
KF20R
Optical



EN14604:2005
LICENSE NO. KM 524754



0086-CPD-535595
14
EN 14604:2005

PLEASE READ AND SAVE

INSTALLER: Please leave this user guide with the product.

SMOKE ALARM DESCRIPTION

- Model KF10, KF10LL** Ionisation 230V AC smoke alarm with 9V battery back-up and Hush Button
- Model KF10R** Ionisation 230V AC smoke alarm with rechargeable battery backup and Hush Button
- Model KF20, KF20LL** Optical 230V AC smoke alarm with 9V battery back-up with Hush Button
- Model KF20R** Optical 230V AC smoke alarm with rechargeable battery back-up and Hush Button

SMOKE ALARM FEATURES

- Interconnects with up to 23 other models, KF1, KF1R, KF2, KF2R, KF3, KF3R, KF10, KF10LL, KF10R, KF20, KF20LL, KF20R, KF30, KF30LL, KF30R, 4870, 4881, 4973, 4985, 4892, 4899, 1SFW, 1SFWR, 2SFW, 2SFWR, 3SFW, 3SFWR, and 4MCO and 4MDCO Mains CO alarms. Unique power connector prevents interconnection with incompatible smoke alarms or security systems.
- Tamper-resist bracket quickly snaps into place and serves as a safeguard against tampering.
- Multi-purpose green and red LEDs indicate that the smoke alarm is receiving AC power, working under normal operation, in alarm, or under Hush Button.
- Loud alarm horn—85 decibels at 3 metres (10 feet)—sounds to alert you of an emergency.
- Test button checks smoke alarm operation.
- All models feature Hush Button, which, when activated, quiets unwanted alarms for up to 9 minutes.
- Models KF10, KF10LL, KF20 and KF20LL will not attach to the mounting bracket if a battery is not in the battery pocket. These models will also sound a short beep about once a minute if the battery is weak or improperly connected.
- Models KF10R, KF20R, KF10LL and KF20LL have lithium batteries that will last the life of the alarm and a tamper-proof locking screw option.
- Models KF10R and KF20R include permanent rechargeable lithium batteries.
- Operating temperature: 0°C to 40°C
- Operates up to 93% humidity (non-condensing)

IMPORTANT SAFETY INFORMATION PLEASE READ AND SAVE THESE INSTRUCTIONS



WARNING

- **DO NOT paint or cover the smoke alarm with tape.**
- **This smoke alarm should be out of the reach of children.**
- **AC smoke alarms require constant 230V AC, 50Hz power to operate properly.** Mains-powered smoke alarms WILL NOT work if AC power is not connected or has failed or been interrupted for any reason. Models KF10, KF10LL and KF20, KF20LL require a working 9-volt battery to operate properly in the event of a power failure. Models KF10R and KF20R require a minimum of 2 full days under mains power to reach full backup capacity. DO NOT use any other kind of battery except as specified in this user guide. DO NOT connect this smoke alarm to any other type of smoke alarm or auxiliary device, except those listed in this user guide.
- **DO NOT remove or disconnect battery or turn off AC power to quiet unwanted alarms.** This will remove your protection. Open windows or fan the air around smoke alarm to silence it. KF10, KF10LL, KF10R, KF20, KF20LL and KF20R smoke alarms feature a Hush Button which, when activated, will quiet unwanted alarms for up to 9 minutes.

- **The Push-to-Test button accurately tests all smoke alarm functions.** DO NOT use any other test method. **Test smoke alarm weekly to ensure proper operation.**
- **This smoke alarm should be installed only by a qualified electrician.**
- **This smoke alarm is designed to be used inside a single family household only.** In multi-family buildings, each individual living unit should have its own smoke alarms. Do not install in non-residential buildings or places which house many people like hotels, motels, dormitories, hospitals, nursing homes, or group homes of any kind. This smoke alarm is not a substitute for a complete alarm system.
- **Install a smoke alarm in every room and on every level of the home.** Smoke may not reach the smoke alarm for many reasons. For example, if a fire starts in a remote part of the home, on another level, in a chimney, wall, roof, or on the other side of a closed door, smoke may not reach the smoke alarm in time to alert household members. A smoke alarm will not promptly detect a fire EXCEPT in the area or room in which it is installed.
- **Interconnected smoke alarms installed in every room and on every level of the household offers maximum protection.** We recommend interconnecting smoke alarms so that when one smoke alarm senses smoke and sounds its alarm, all others will sound as well. Do not interconnect smoke alarms from one individual family living unit to another. Do not connect this smoke alarm to any other type of alarm or auxiliary device.
- **Smoke alarms may not alert every household member every time.** The alarm horn is loud in order to alert individuals of a potential danger. However, there may be limiting circumstances where a household member may not hear the alarm (i.e. outdoor or indoor noise, sound sleepers, drug or alcohol usage, the hearing impaired, etc.). If you suspect that this smoke alarm may not alert a household member, install and maintain specialty smoke alarms. Household members must hear the alarm's warning sound and quickly respond to it to reduce the risk of damage, injury, or death that may result from fire. If a household member is hearing impaired, install special smoke alarms with lights or vibrating devices to alert occupants.
- **Smoke alarms can only sound their alarms when they detect smoke.** Smoke alarms detect combustion particles in the air. They do not sense heat, flame, or gas. This smoke alarm is designed to give audible warning of a developing fire. However, many fires are fast-burning, explosive, or intentional. Others are caused by carelessness or safety hazards. Smoke may not reach the smoke alarm QUICKLY ENOUGH to ensure safe escape.
- **Smoke alarms have limitations.** This smoke alarm is not fool-proof and is not warranted to protect lives or property from fire. Smoke alarms are not a substitute for insurance. Homeowners and renters should insure their lives and property. In addition, it is possible for the smoke alarm to fail at any time. **For this reason, you must test the smoke alarm weekly and replace every 10 years.**

SMOKE ALARM PLACEMENT

It is recommended to achieve complete coverage protection by installing a smoke alarm in every room of your home.

At a minimum, smoke alarms shall be installed outside or inside all bedrooms and on each additional storey of the family living unit including basements, and converted loft spaces. Any home requires a minimum of two smoke alarms.



Typical Single Storey Home

- Install a smoke alarm on the ceiling or wall inside each bedroom and in the hallway outside each separate sleeping area. If a bedroom area hallway is more than 9 m long, install a smoke alarm at each end.

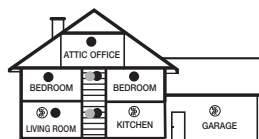
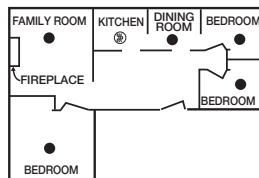

Typical Two-Storey Home

- Install a smoke alarm on the ceiling inside each bedroom and in the hallway outside each separate sleeping area.

If a bedroom area hallway is more than 9 m long, install a smoke alarm at each end.

- Install a smoke alarm at the top and bottom of a first-to-second floor stairwell.

Key	
●	Ionisation Alarm
○	Optical Alarms
⊗	Heat Alarm

IMPORTANT SMOKE ALARM PLACEMENT AND EXCEPTION INFORMATION:

- Install a smoke alarm as close to the centre of the ceiling as possible. If this is not practical, mount no closer than 30cm (12 inches) from a wall or corner. Also, if local codes allow, install smoke alarms on walls, 30 cm (12 inches) from ceiling/wall intersections.
- Install a minimum of two smoke alarms in every home, no matter how small the home. Any size home requires fitting a minimum of two smoke alarms.
- Install a smoke alarm in each room that is divided by a partial wall (either coming down from the ceiling at least 20 cm (8 inches), or coming up from the floor).
- Install smoke alarms on peaked, cathedral, or gabled ceilings 1 m from the highest point (measured horizontally).
- Install a smoke alarm in lived-in attics or attics which house electrical equipment like furnaces, air conditioners, or heaters.

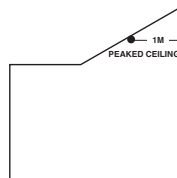
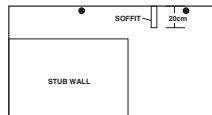
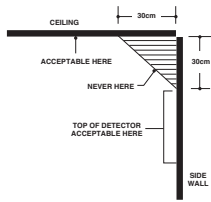

Locations to be Avoided (Smoke Alarms)

- ⊖ Do not site within 3m of a steam source e.g. kitchen/bath room or garage.
- ⊖ Do not site within 1m of dimmer control cabling or cable alarm into any such cabling.
- ⊖ Do not site adjacent to any heat source.
- ⊖ Do not site within 300mm (12") of any lights fixture and 300mm from any wall.
- ⊖ Do not site near fluorescent lights; electronic noise may cause nuisance alarms.
- ⊖ In locations where temperature may fall below 0°C (40°F), or above 40°C (104°F).
- ⊖ In areas with relative humidity (RH) above 93% (non-condensing).
- ⊖ In very dusty/dirty/insect laden areas.
- ⊖ Any location where the free flow of smoke to the alarm could be interrupted (e.g. next/above a door/air vent/heater/air-con unit).
- ⊖ Areas where routine maintenance or operating hush/test button is difficult (e.g. top of stairwells).
- ⊖ Siting should be in accordance with the current Building Regulations and/or BS5839 Pt6/current I.E.E. Regulations.

⚠ CAUTION: Alarm should not be exposed to dripping or splashing.

HOW TO INSTALL THIS SMOKE ALARM

⚠ DANGER:

ELECTRICAL SHOCK HAZARD. Turn off power at the main consumer unit or circuit breaker by removing the fuse or switching the circuit breaker to the OFF position and securing it.

⚠ WARNING:

Mains operated smoke alarms should be installed by a qualified electrician in accordance with the Regulations for Electrical Installations published by the Institution of Electrical Engineers (BS). Failure to install this smoke alarm correctly may expose the user to shock or fire hazards.

⚠ WARNING:

The smoke alarm, its associated supply and interconnect wiring must be installed in accordance with BS 7671 published by the Institution of Electrical Engineers.

⚠ WARNING:

If a Firex Rechargeable alarm is replacing an earlier non rechargeable model, the new cable harness with 4 strands must be used. Using the old 3 strand harness will not allow new rechargeable alarm to charge it's batteries.

- Install smoke alarm on ceiling, standard electrical box, or surface mounting pattress.
1. Align mounting plate with mounting holes of standard electrical box or surface mounting pattress. For siting on ceiling, use mounting plate as template to mark holes. Drill holes and insert supplied screw plugs into holes until flush with ceiling. Ceiling mounting is always preferable over wall mounting.
 2. Secure mounting plate to electrical box, pattress or ceiling. (Diagram illustrates fixing mounting plate to electrical box.)
 3. Connect blue cable from connector plug of smoke alarm to neutral

replace with (N) mains power cable.

- Connect brown cable from connector plug of smoke alarm to live (L) mains power cable.
- If interconnection is desired, connect orange or white cable from connector to interconnect strand on the 3 core & earth cable. See section, "Interconnecting Smoke Alarms."

NOTE: If this will be a single-station smoke alarm, cover orange or white

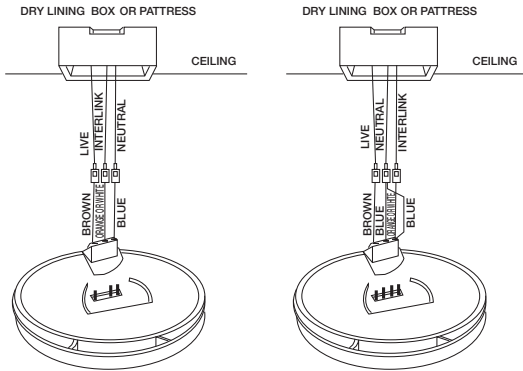

**MODELS KF10, KF10LL,
KF20, KF20LL**

MODELS KF10R, KF20R (Rechargeable)

cable with electrical tape and tuck into pattress.

Steps 6-9 for Models KF10, KF10LL, KF20, KF20LL ONLY:

- Lift open battery pocket door.
- Connect new 9-volt battery to battery connector inside battery pocket. **BE SURE BATTERY IS SECURELY CONNECTED.** Smoke alarm may beep briefly when battery is installed.
- Close battery pocket door, snapping it into place.
- KF10LL and KF20LL include a tamper-proofing locking option, using the screw provided
- Push button and hold button on front cover of smoke alarm for three (3) seconds. Smoke alarm should sound its alarm horn if battery is fitted correctly.
- Attach connector plug to pins on back of smoke alarm. Plug will only fit one way and will snap into place.
- Gently tug connector to be sure it is attached securely.
- Position smoke alarm to mounting plate so that keyslot on side of smoke alarm is to left of tab on mounting plate. Turn clockwise to lock into place.

NOTE: (For Models KF10, KF10LL, KF20 and KF20LL only):

Smoke alarm will not mount to plate if battery is not installed.

- Turn on power at main fuse box or circuit breaker. The green LED on the cover should be illuminated.
- Test smoke alarm. See "TESTING THE SMOKE ALARM".

INTERCONNECTING SMOKE ALARMS

- Use 1.5mm² minimum solid or stranded cable with a rating of 230V. When interconnecting, maximum cable length between any two is 450 m for 1.5mm² or 1200 m for 2.5mm² (20 OHMS loop resistance).
- NOTE:** Maximum length under BS7671 17th Edition wiring regs amendment 1 for CB/RCBO type B is 72 metres for TN-S or TN-C-S systems (source "On-Site Guide" page 59)
- This smoke alarm may be interconnected with as many as 23 other Models smoke alarms, as listed on page 1. **DO NOT** connect to any other type or model smoke alarm.
- Connect smoke alarms to a single circuit. Wiring must conform to IEE

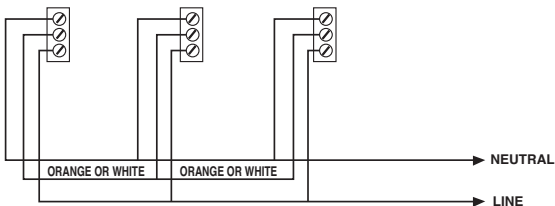

FOR INTERCONNECT: USE STANDARD 3 core & earth cable 1.5mm² cable

Regulations for electrical installation.

RED AND GREEN LED INDICATORS

This smoke alarm features red and green LED indicators that can be seen through the Push-to-Test button or the LED lens above the test button. The LEDs indicate the following:

GREEN LED

ON — AC power is present.

OFF — AC power is not present.

RED LED

Blinks once every 5 minutes AND 20 SECONDS — indicating normal operation.

- Blinks once a second — smoke alarm senses smoke and simultaneously sounds an audible alarm.
- Blinks once every 10 seconds — smoke alarm is in hush mode.
- (Interconnected system only):
- 3 rapid flashes at 40 second intervals — indicates which alarm previously detected an alarm condition.
- OFF** — another smoke alarm in the network has sensed smoke and is signalling this alarm.

HUSH BUTTON

Models KF10, KF10LL, KF10R, KF20, KF20LL and KF20R feature Hush Button that, when activated, quiets unwanted alarms for up to 9 minutes.

To use the Hush Button:

Press and release the test button during an unwanted alarm. The alarm should stop within ten seconds. This means the smoke alarm is in Hush Button. If the smoke alarm does not go into Hush and continues to sound its loud alarm horn, or if it initially goes into Hush then resounds the alarm, the smoke is too heavy and could be a dangerous situation – take emergency action.

TESTING THE SMOKE ALARM



WARNING

- Test each smoke alarm to be sure it is installed correctly and operating properly.
- Test all smoke alarms in an interconnected system after installation.
- The Push-to-Test button accurately tests all functions. DO NOT use an open flame to test this smoke alarm. You may ignite and damage the smoke alarm or your home.
- Test smoke alarms weekly and upon returning from holiday or when no one has been in the household for several days.
- Stand at arm's length from the smoke alarm when testing. The alarm horn is loud to alert you to an emergency and can be harmful to hearing.

Test all smoke alarms weekly by doing the following:

1. Check Push-to-Test button. A constant green light indicates the smoke alarm is receiving 230V AC, 50Hz power. A red flashing LED about once every 5 minutes verifies operation. For models KF10, KF10LL, KF10R, KF20, KF20LL and KF20R the red flashing LED also verifies that a working battery is present.
2. Firmly depress and hold the Push-to-Test button for at least five (5) seconds. The smoke alarm will sound a loud beep about three (3) times a second. The alarm may sound for up to 10 seconds after releasing the Push-to-Test button.

NOTE: If smoke alarms are interconnected, all smoke alarms should sound an alarm within three seconds after any test button is pushed and the tested smoke alarm sounds.

3. If smoke alarm does not sound, turn off power at main fuse box or circuit breaker and check wiring. Retest smoke alarm.

⚠ DANGER: If alarm horn sounds, and smoke alarm is not being tested, the smoke alarm is sensing smoke. THE SOUND OF THE ALARM HORN REQUIRES YOUR IMMEDIATE ATTENTION AND ACTION.

MAINTENANCE AND CLEANING

In addition to weekly testing, Models KF10 and KF20 also require periodic battery replacement. Regularly clean smoke alarm to remove dust, dirt, and debris.

⚠ WARNING: Alarm comes equipped with a dust cover, which prevents dust and debris from damaging the unit during construction or remodeling. Remove dust cover before operation. Alarm will not operate properly while covered.

⚠ DANGER: ELECTRICAL SHOCK HAZARD. Turn off main power at fuse box or consumer unit by removing fuse or switching appropriate circuit breaker to OFF position before replacing battery or cleaning smoke alarm.

BATTERY REPLACEMENT (For Models KF10 and KF20 only):

⚠ CAUTION: Danger of explosion if battery is incorrectly replaced.

Always turn off power to smoke alarm before replacing battery. Replace battery at least once a year or immediately when the low battery signal sounds once every 40 seconds, even though the smoke alarm is receiving AC power. Use only the following 9V/(6F22) batteries as replacements in this smoke alarm: Energizer 522; Duracell MN1604 or MX 1604; or FDK CP-V9Ju; Ultralife U9VL-J-P
Replace only with the same or equivalent battery type recommended

by the manufacturer. Discard used batteries safely according to manufacturer's instructions.

WHENEVER THE BATTERY IS REPLACED, TEST THE ALARM FOR CORRECT OPERATION PUSHING THE TEST BUTTON.

⚠ WARNING: DO NOT USE ANY OTHER TYPE OF BATTERY, EXCEPT AS SPECIFIED IN THIS USER GUIDE. DO NOT USE RECHARGEABLE BATTERIES.

1. Turn off power to smoke alarm at main consumer panel.
2. Insert a small screwdriver into the slot in the mounting plate. Depress locking tab with the screwdriver and turn smoke alarm counter-clockwise to detach from mounting plate.
3. Gently pull down smoke alarm. Be careful not to separate cable connections.
4. Pull out power plug from back of smoke alarm.
5. From back of smoke alarm, lift tab to open battery pocket door.
6. Remove battery from pocket. Disconnect and discard drained battery from battery connector.
7. Connect a fresh, 9-volt battery to connector. The battery will fit only one way. Be sure battery connector is securely attached to battery terminals. Smoke alarm may sound a short beep when battery is installed. This is normal and means the battery is installed correctly.
8. Place battery into battery pocket.
9. Close battery pocket door. **Push down until it snaps into place.**
10. Press and hold test button. The alarm will sound if the battery is properly connected and working.
11. Replace connector plug. Connector will snap into place. Gently tug connector to be sure it is attached properly.
12. Reattach smoke alarm to mounting plate by turning smoke alarm clockwise until it snaps into place.
13. Turn on power and test smoke alarm using test button.

(For Models KF10R and KF20R only):

NOTE: Rechargeable lithium batteries are permanently mounted and sealed in the tamper-proof housing. These cells are designed to last the useful life of the smoke alarm.

CLEANING

Clean the smoke alarm at least once a month to remove dust, dirt, or debris. Always turn off power to smoke alarm before cleaning.

- Using the soft brush or wand attachment to a vacuum cleaner, vacuum all sides and cover of smoke alarm. Be sure all the vents are free of debris.
- If necessary, turn off power and use a damp cloth to clean smoke alarm cover.

IMPORTANT: Do not attempt to remove the cover or clean inside the smoke alarm. THIS WILL VOID YOUR GUARANTEE.

REPAIR

⚠ CAUTION: Do not attempt to repair this smoke alarm. Doing so will void your guarantee.

If smoke alarm is not operating properly, see "Troubleshooting". If necessary and if still under guarantee, return smoke alarm to Kidde. Pack it in a well-padded carton and send, postage prepaid to Kidde address at the end of this user guide.

If the smoke alarm is no longer under guarantee, have a qualified electrician replace the smoke alarm immediately with a comparable Firex smoke alarm.

PRACTICE FIRE SAFETY

If the smoke alarm sounds its alarm horn, and you have not pushed the test button, it is warning of a dangerous situation. Your immediate response is necessary. To prepare for such occurrences, develop family escape plans, discuss them with ALL household members, and practice them regularly.

- Expose everyone to the sound of a smoke alarm and explain what the sound means.
- Decide on TWO exits from each room and an escape route to the outside from each exit.
- Teach all household members to touch the door and use an alternate exit if the door is hot. **INSTRUCT THEM NOT TO OPEN THE DOOR IF THE DOOR IS HOT.**
- Teach household members to crawl along the floor to stay below dangerous smoke, fumes, and gases.
- Decide on a safe meeting place for all members to meet outside the building.

WHAT TO DO IN CASE OF A FIRE

1. Don't panic; stay calm.
2. Leave the building as quickly as possible. Touch doors to feel if they are hot before opening them. Use an alternate exit if necessary. Crawl along the floor, and **DO NOT** stop to collect anything.
3. Meet at a pre-arranged meeting place outside the building.
4. Call the fire brigade (Dial 999) from **OUTSIDE** the building.
5. **DO NOT GO BACK INSIDE A BURNING BUILDING.** Wait for the fire brigade to arrive.

These guidelines will assist you in the event of a fire. However, to reduce the chance that fires will start, practice fire safety rules and prevent hazardous situations

TROUBLESHOOTING

⚠ DANGER: Always turn off power at main fuse box or consumer unit before taking trouble-shooting action.

⚠ WARNING: **DO NOT** disconnect battery or mains power to quiet an unwanted alarm. This will remove your protection. Fan the air or open a window to remove smoke or dust. For Models KF10, KF10LL, KF10R, KF20, KF20LL and KF20R you may also use the Hush Button feature to quiet unwanted alarms.

PROBLEM	SOLUTION
<p>Smoke alarm does not sound when tested.</p> <p>NOTE: Push and hold test button for at least five (5) seconds while testing!</p>	<ol style="list-style-type: none"> 1. Check that AC power is turned on. Green LED should be illuminated. 2. Turn off power. Remove smoke alarm from mounting plate and: <ol style="list-style-type: none"> a. check that connector plug is securely attached. b. check that battery is properly attached to connector. 3. Clean smoke alarm.
<p>Smoke alarm beeps once every 40 seconds</p> <p>(KF10 and KF20 only)</p> <p>(KF10R and KF20R) item #3</p>	<ol style="list-style-type: none"> 1. Turn off power and replace battery. See in the MAINTENANCE AND CLEANING section. 2. Clean smoke alarm. 3. Verify that unit has been under mains operation for a minimum of 2 full days. If the beeping persists after required charging period, return the unit for service.
<p>Smoke alarm sounds unwanted alarms when residents are cooking, taking showers, etc.</p> <p>Interconnected smoke alarms do not sound when system is tested.</p>	<ol style="list-style-type: none"> 1. Hire an electrician to move smoke alarm to a new location. See "SMOKE ALARM PLACEMENT". 1. Press and hold test button for at least three seconds after the first unit sounds. 2. Hire an electrician to ensure smoke alarms are properly connected.
<p>3 chirps every 40 seconds</p>	<p>Ten (10) year end of life warning. Alarm must be replaced (REPLACE IMMEDIATELY!)</p>

GUARANTEE

The manufacturer warrants to the original consumer purchaser each new smoke alarm to be free from defects in material and workmanship under normal use and service for a period of six (6) years in the United Kingdom and Republic of Ireland from date of purchase. We agree to repair or replace, at its option, any defective smoke alarm, provided that it is returned with postage prepaid and with proof of purchase date to the manufacturer. This warranty does not cover damage resulting from accident, misuse or abuse or lack of reasonable care of the product. This warranty is in lieu of all other express warranties, obligations or liabilities. THE IMPLIED WARRANTIES OF MERCHANTABILITY AND FITNESS FOR A PARTICULAR PURPOSE ARE LIMITED TO A PERIOD OF SIX (6) YEARS FROM PURCHASE DATE. IN NO CASE SHALL THE MANUFACTURER BE LIABLE FOR ANY INCIDENTAL OR CONSEQUENTIAL DAMAGES FOR BREACH OF THIS OR ANY OTHER WARRANTY, EXPRESS OR IMPLIED, WHATSOEVER, EVEN IF THE LOSS OR DAMAGE IS CAUSED BY ITS NEGLIGENCE OR FAULT.

Return units freight prepaid to your local reseller. For information on your local reseller in the U.K. and Republic of Ireland, contact:

FIREX PRODUCTS

KIDDE SAFETY EUROPE LIMITED

Mathisen Way
Colnbrook, Berkshire SL3 0HB
United Kingdom
Tel.: +44 (0) 1753 685148

www.smoke-alarms.co.uk

Leading authorities recommend that both Ionisation and photoelectric smoke alarms be installed to insure maximum detection of the various types of fires that can occur within the home. Ionisation sensing alarms may detect invisible fire particles (associated with fast flaming fires) sooner than photoelectric alarms. Photoelectric sensing alarms may detect visible fire particles (associated with slow smouldering fires) sooner than Ionisation alarms.