

Super Xpress - SXD iQ

120-150-180-210-250-300 l.

EN



SAFETY INFORMATION
O&M INFORMATION
INSTALLATION MANUAL
TDS - TECHNICAL DATA SHEET



Manufactured by OSO Hotwater AS
Industriveien 1 - 3300 Hokksund - Norway
Tel.: +47 32 25 00 00 / Fax: +47 32 25 00 90
E-mail: oso@oso.no / www.osohotwater.com

142228-00 - 05-2018



CONTENTS

1. General information

1.1 Product identification.....	4
1.2 CE Marking.....	4
1.3 Erp Data.....	4
1.4 General information.....	4
1.5 Handling.....	5
1.6 Clearances.....	5

2. Installation.

2.1 Health and safety regulations.....	6
2.2 Siting the Super SX.....	6
2.3 Component check list.....	6
2.4 Supply requirements.....	6
2.5 Expansion vessels.....	6
2.6 Wall mounting.....	6
2.7 Preliminary wiring.....	7
2.8 Pipework.....	7
2.9 Electrical connections.....	7
2.10 Pipe connections.....	8
2.11 Vessel connections.....	8
2.12 Remove the template.....	8
2.13 Combination valve.....	8
2.14 Cold mains supply.....	8
2.15 Hot water outlet.....	8
2.16 Balanced cold water supply.....	8
2.17 Expansion vessel (300 litre).....	8
2.18 Flexible Y. Hose.....	8
2.19 Tundish.....	8
2.20 Secondary return.....	8
2.21 Discharge pipe.....	9

3. Commissioning

3.1 Commissioning and filling.....	9
3.2 Draining.....	9
3.3 System flushing.....	9

4 Electrical installation

4.1 Immersi on heaters.....	10
4.2 Wiring of immersion heaters.....	10
4.3 Smart control settings.....	11
4.4 Smart technology.....	12
4.5 Smart control RED LED indicator.....	13
4.6 Software reset.....	13
4.7 Anti-Legionella Cycle.....	13
4.8 Smart control OFF PEAK function.....	13
4.9 Smart control power supply.....	13
4.10 Smart control technical data.....	14

5. Safety and servicing

5.1 Safety cut out.....	15
5.2 Intermittent discharge from tundish.....	15
5.3 Continuous hot discharge from tundish.....	15
5.4 Expansion vessel maintenance.....	15
5.5 Guarantee.....	15
5.6 Service procedure.....	15
5.7 Combination valve.....	16
5.8 Drain cock.....	16
5.9 Alternative discharge.....	16

6. OSO fault finding guide.....17

7. Technical specification

Commisioning and service logbook.....	19
Service interval record.....	23





8. Guarantee conditions

Guarantee.....	22
8.1 Customer service.....	22

9. Removing the product

9.1 Removal.....	22
9.2 Returns scheme.....	22

Symbols used in this manual:







 WARNING	Could cause serious injury or death
 CAUTION	Could cause minor or moderate injury or damage to property
	DO NOT
	DO



	This document should be kept in a suitable place where it is accessible for future reference.
---	---

Safety instructions







- Read the following safety instructions carefully before installing, maintaining or adjusting the water heater.
- Personal injury or material damage may result if the product is not installed or used in the intended manner.
- Keep this manual and other relevant documents where they are accessible for future reference.
- The manufacturer assumes compliance (by the end-user) with the safety, operating and maintenance instructions supplied and (by the installer) with the fitting manual and relevant standards and regulations in effect at the date of installation.





Safety instructions for users

 WARNING	
	The overflow from the safety valve must NOT be sealed or plugged.
	The product must NOT be covered over the cover on the front.
	The product must NOT be modified or changed from its original state.
	Children must NOT play with the product or go near it without supervision.
	The product should be filled with water before the power is switched on.
	Maintenance/settings should only be carried out by persons over 18 years of age, with sufficient understanding

 CAUTION	
	The product must not be exposed to frost, over-pressure, over-voltage or chlorine treatment. See warranty provisions.
	Maintenance/settings should not be carried out by persons of diminished physical or mental capacity, unless they have been instructed in the correct use by someone responsible for their safety.

Safety instructions for installers

 WARNING	
	The overflow from the safety valve must NOT be sealed or plugged.
	Discharge must comply with current building regulations.
	Fixed electric fittings should be used for installation in new homes or when changing an existing electrical setup in accordance with regulations.
	The mains cable should withstand 90°C. A strain reliever must be fitted.
	The product should be filled with water before the power is switched on.
	The relevant regulations and standards, and this installation manual, must be followed.

 CAUTION	
	The cylinder must be installed complying with current building regulations. Liability for consequential damage will only apply if this is followed.
	The product should be properly aligned vertically and horizontally, on a floor or wall suitable for the total weight of the product when in operation. See type plate.
	The product must have a clearance for servicing of 40 cm in front of the cover / over the mixer valve.

1. GENERAL INFORMATION

1.1 Product Identification

Identification of your product can be found on the label attached to the product. The label contains information about the product according to EN 12897: 2016 and EN 60335-2-21, in addition to other useful data. See Declaration of Conformity at www.osohotwater.com for more information

OSO products are designed and manufactured according to:

- Tank standard EN 12897:2016
- Safety standard EN 60335-2-21
- Welding standard ISO 3834-2

OSO Hotwater AS is certified according to

- Quality ISO 9001
- Environment ISO 14001
- Working Environment OHSAS 18001

1.2 CE marking



The CE mark shows that the product complies with the relevant Directives. See Declaration of Conformity at www.osohotwater.co.uk for more information.

The product complies with the directives for:

- Low voltage LVD 2014/35/EU
- Electromagnetic compatibility EMC 2014/30/EU
- Press Equipment PED 2014/68/EU

1.3 ErP data - Technical Data Sheet

TDS - Technical Data Sheet - Direct electric water heater - ErP data

Directive: 2010/30/EU Regulation: EU 812/2013		Directive: 2009/125/EC Regulation: EU 814/2013		Water heater efficiency according to standard: EN 50440: 2015					
Trade mark	M.T. item no.	Model/identifier		ErP profile	ErP Rating	Energy eff. %	AEC kWh/a	Th. stat setting	Storage volume L
OSO Hotwater AS	10802651	SX120 - 2.8kW @ 230V/3.0kW @ 240V iQ		M	C	38	1336	70	111
OSO Hotwater AS	10802652	SX150 - 2.8+2.8kW @230V/3.0+3.0kW @ 240V iQ		L	C	38	2670	70	143
OSO Hotwater AS	10802653	SX180 - 2.8+2.8kW @230V/3.0+3.0kW @ 240V iQ		L	C	40	2559	70	164
OSO Hotwater AS	10802654	SX210 - 2.8+2.8kW @230V/3.0+3.0kW @ 240V iQ		L	C	39	2641	70	193
OSO Hotwater AS	10802655	SX250 - 2.8+2.8kW @230V/3.0+3.0kW @ 240V iQ		XL	C	39	4298	70	242
OSO Hotwater AS	10802656	SX300 - 2.8+2.8kW @230V/3.0+3.0kW @ 240V iQ		XL	C	39	4325	70	280

1.4 General information

Thank-you for purchasing the OSO Super SX unvented hot water cylinder. Designed to be simple and neat to install, the Super SX differs from other unvented cylinders in that all of the principle connections, including hot and cold water pipes and expansion vessel are connected to the top of the cylinder. Full size template is provided to facilitate pipe positioning.

OSO advise that the connecting pipes and electrical cables are fixed in place prior to the positioning of the cylinder. Moving the cylinder into position should be the last thing done before connection of pipes and commissioning of the cylinder.

This manual gives detailed advice for installation and should be read carefully prior to fitting any unvented unit. OSO Super SX cylinders are not suitable for gravity fed primary systems. In known hard water regions, precautions should be taken to prevent limescale formation in hot water cylinders, in accordance with Building Regulation Part L, Domestic Heating Compliance Guide.

This OSO cylinder must be installed by a competent person and be installed in compliance with the OSO Installation and Maintenance Instructions, all current legislation, codes of practice and regulations governing the installation of unvented hot water cylinders in force at the date of installation.

1.5 Handling, location and positioning

The product should be transported carefully as shown, with packaging. Use the handles in the box.

⚠ CAUTION

Tappings, valves etc. should not be used to lift the product as this could cause malfunction.

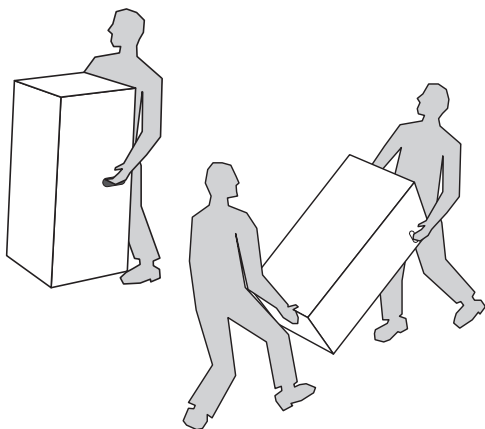

⚠ CAUTION

- | | |
|---|---|
| ❗ | The cylinder must be installed complying with current building regulations. |
| ❗ | The product should be placed in a dry and permanently frost-free position. |
| ❗ | The product should be placed on a floor or wall suitable for the total weight of the product when in operation. See type plate. |
| ❗ | The product must have a clearance for servicing of 40 cm in front of the cover / 10 cm over the mixer valve. |
| ❗ | The product should be easily accessible in the home for servicing and maintenance. |

1.6 Clearances

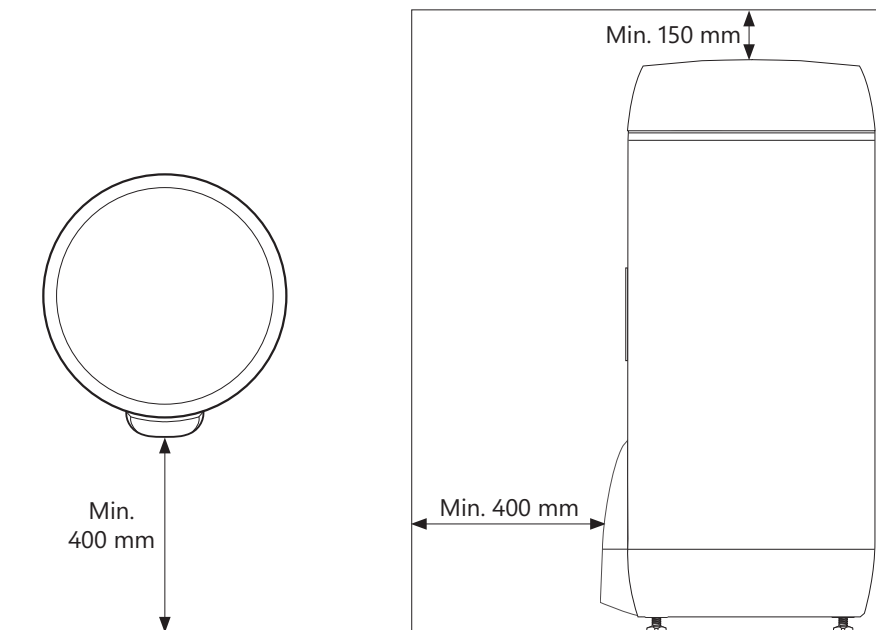

2. INSTALLATION

2.1 Health and safety regulations

Handling Operations Regulations 1992 defines manual handling as: "any transporting or supporting of a load (including the lifting, putting down, pushing, pulling, carrying or moving thereof by hand or bodily force". The Regulations set no specific requirements such as weight limits. However common sense still has to be used based on an ergonomic approach for each individual. The Super SX should be transported and stored in a vertical position.

2.2 Siting the Super SX

The cylinder should not be positioned until the connecting pipework and cables are fitted. There are few restrictions on the siting of the OSO Super SX, however it should not be sited anywhere open to frost attack. The unit should be placed on a stable flat surface capable of withstanding the weight of the cylinder when full (see table on page 20) and access must be allowed for maintenance purposes. Prior to positioning the cylinder, wind out the feet in the base to protrude by 10 mm (35 mm if using optional wall bracket). If wall mounted with an OSO wall bracket, the wall should be capable of withstanding the forces generated by the weight of the full cylinder. Provision should also be allowed for the routing of the discharge pipe away from the cylinder to an outside point according to building regulation G3.

2.3 Component check list

Components supplied with the unit in a separate accessory kit for site fitting:

- Expansion vessel with wall bracket (300 l. only)
- Tundish (incl. screws)
- Plastic cable clamp

Components factory fitted:

- Expansion vessel(s) with T piece connector
- Flexible hose for expansion vessel
- Combination valve, includes line strainer, pressure reducing valve, balanced cold water connection (for shower or bidet only), blanking cap for balanced cold water connection, temperature & pressure relief valve and hot water blending valve.

Documentation supplied:

- Installation manual & service logbook

- Template for connecting pipework
- Immersion heater(s) - 3 kW
- Thermostat(s) / thermal cut-out
- Drain cock
- Lid for cylinder.

2.4 Supply requirements

An uninterrupted 22 mm cold water mains supply is recommended, however if only a 15 mm supply is available, this may be used provided there is sufficient flow rate available. A minimum standing pressure of 2.5 bar and a flow rate of 20 litres per minute with a 1 bar dynamic pressure is recommended. The cylinder will operate at lower pressures and flow rates however the performance will be compromised. The OSO unvented unit is designed for use with supply pressure up to 8 bar. For pressures over 8 bar an additional pressure reducing valve must be fitted in the supply pipe to the unit.

2.5 Expansion vessel

Super SX 120-250: Twin expansion vessels (single on 120) are factory fitted to the multifunction valve using the supplied flexible hose. SuperSX 300: An external expansion vessel is provided to be connected to the multifunction valve. The vessel(s) accommodate expanded water when the cylinder is heated and prevents the cylinder reaching its maximum working pressure.

2.6 Wall mounting

Wall mounting brackets are available for OSO unvented units Super SX 120-180.

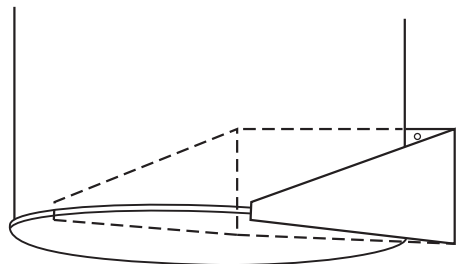

2.7 Preliminary wiring

Before final installation and pipe fitting it is recommended to feed the electrical wires to the electrical box. The OSO Super SX is provided with two channels in the base to feed electrical cables to the cylinder. The channels run diagonally from the front centre to the rear left and right, and ensures a neat installation with minimum visible cabling.

When the cylinder is moved into position remove the electrical box covers. The power cables should be fed up from the base channels into the electrical box. When cables are connected they must be secured using the cable clamp (1) supplied in the fittings bag.

All cables should comply with BS6141 table 8 HOFR 85c. Cables should be sufficient length to reach from the junction box through the base channels and leave an amount of tail from the front of the cylinder sufficient to reach the electrical connection point.

For more information about electrical installations see chapter 4. ELECTRICAL INSTALLATION.

2.8 Pipework

The OSO Super SX has all pipework connections at the top of the cylinder with these pipes secured to the rear wall. A template is provided to assist in the placement of these pipes. Decide where the cylinder is to be positioned and secure the wall template with the cross on the back wall at least 326 mm from the left wall.

Ensure the cylinder feet are wound out to protrude correct amount. Refer to included template to position the cross at the correct height above the base for the appropriate capacity of the cylinder. Please note that if the cylinder is raised on its feet or on a plinth higher than floor level, the height of the template above the floor will need to be raised accordingly.

The connecting pipe tails should be fitted so they reach out away from the back wall horizontally, perpendicular to the wall and parallel with each other. The table below shows the exact lengths

these tails should be cut from wall to reach the cylinder connections. If pipes are clipped up the back wall behind the cylinder position, the tails should be longer. Use the lengths marked 'below'. If the pipes approach the template points from above/side, use the lengths marked 'above'.

OSO recommend that the discharge pipe should be located at the left side of the cylinder.

Tail lengths from wall	Above	Below
Cold feed in	202	242
Hot water out	274	314
Balanced cold water out	188	228

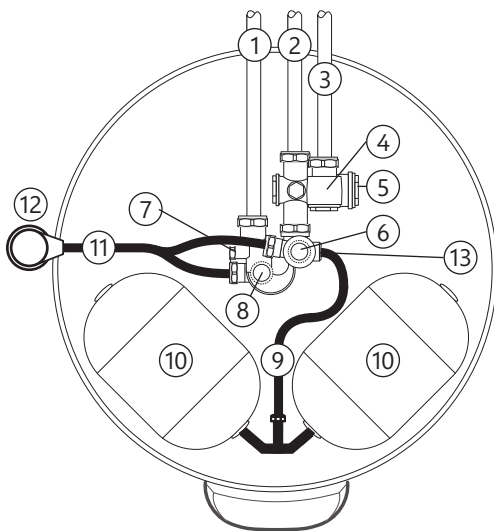

No.	Description	Dim.
1	Domestic hot water outlet (DHW out)	ø22 mm
2	Balanced cold water connection (Bal. CW)	ø22 mm
3	Cold water main supply inlet (CW in)	ø22 mm
4	Line strainer	-
5	Pressure reducing valve - 3 bar	-
6	Expansion relief valve - 8 bar	1/2"
7	Hot water blending valve	-
8	Temp&pressure relief valve - 90°C / 10 bar	1/2"
9	Flexible hose and T-piece (120-250 l. only)	-
10	Expansion vessel(s) (120-250 l. only)	-
11	Flexible Y-hose	-
12	Tundish	-
13	Expansion vessel connection point	1/2" BSPM

2.10 Pipe connections

Before connecting the cold supply (3), flush the cold supply pipework of all flux and debris. Lift off the cylinder lid to allow access to the combination valve and other connections.

2.11 Vessel connections

Check the expansion vessel(s) and hose connections are tight. SX 300: Fit the expansion vessel and bracket on a suitable wall close to the cylinder.

2.12 Remove the template

Position the cylinder to meet the heating and domestic water pipes.

2.13 Combination valve

The combination valve at the top of the cylinder is factory fitted and is water-tight. If necessary it can be rotated in either direction to suit the connecting pipework, up to half a turn without losing its seal.

2.14 Cold mains supply

Connect the cold mains supply to the combination valve cold feed (see illustration below). The OSO unvented unit is designed for use with supply pressure up to 8 bar. For water pressures above 8 bar an additional pressure reducing valve must be fitted to the cold water supply pipe.

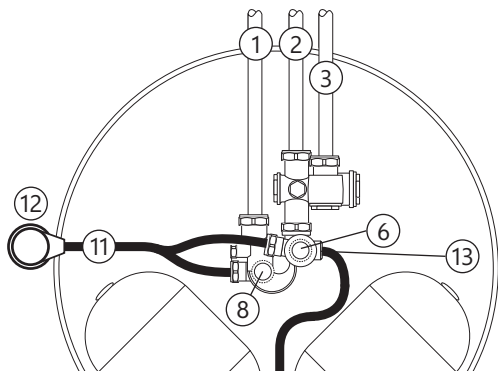

No.	Description	Dim.
1	Domestic hot water outlet (DHW out)	ø22 mm
2	Balanced cold water connection (Bal. CW)	ø22 mm
3	Cold water main supply inlet (CW in)	ø22 mm

2.15 Hot water outlet

Connect the hot water distribution pipe to the combination valve hot water outlet (see illustration).

2.16 Balanced cold water supply (optional)

If no balanced cold supply is required, tighten the supplied blanking cap. If a balanced mains pressure cold water supply is required to a shower or bidet (over rim type only, ascending spray type requires type AA, AB or AD air gap), remove blanking cap and connect to the shower or bidet cold supply (2) on the combination valve. Major shower manufacturers advise fitting a mini expansion vessel in the balanced cold supply pipework to accommodate thermal expansion and prevent tightening of shower controls.

Do not use the balanced cold connection to feed any outlets other than mixer showers. Under no circumstances use the balanced cold connection to feed all cold water outlets as this practice contravenes water regulations.

2.17 Expansion vessel (300 l. only)

Site the expansion vessel on the wall using the supplied bracket and connect to the expansion vessel connecting point (13) on the multifunction valve with copper pipe.

2.18 Flexible Y-hose

The flexible Y-hose (11) is preformed to the correct shape. Connect the inlet ends to the expansion relief valve (6) and the temperature and pressure relief valve (8).

2.19 Tundish

Recommended position of the tundish (12) is to the left of the cylinder as seen from the front. Connect the tundish inlet to the outlet end of the flexible Y-hose (11). Tundish should be visible and positioned away from electrical devices. Tundish can be secured with supplied screws.

2.20 Secondary return (optional)

If a secondary return is connected reduce thermostat settings to 'smart -' (if you require water to remain at 70 an additional potable expansion vessel is required) A secondary return can

be connected via the expansion vessel connection to the combination valve. Remove the hose, connect a short length of 15 mm copper tube, fit a T piece, connect in the secondary return and reconnect the expansion vessel hose to the remaining T piece outlet. An additional expansion vessel will be required if the secondary return 'loop' exceeds 10% of the cylinder capacity.

1 metre of 22 mm pipe holds approximately 1/3 litre of water. 15 mm pipes carry approximately half that volume. Secondary return must be pumped by a bronze pump and fitted with non return valves to ensure correct direction of flow.

2.21 Discharge pipe

Connect the tundish outlet to the discharge pipe. Install the tundish in a vertical position within a maximum of 500 mm from the Temperature and Pressure Relief Valve drain connection. Ensure the expansion relief pipework discharges through the tundish. Tundish pipework must be 22 mm with a minimum vertical length of 300 mm below tundish. Maximum permitted length of 22 mm pipework is 9 m.

Each bend or elbow is equivalent to 0.8 m of pipework. All pipework must have continuous fall and discharge in a safe, visible position. If any doubt, refer to Building Regulation G3. Discharge pipe must be dedicated to the cylinder and must not be used for any other purpose.

3. COMMISSIONING

3.1 Commissioning and filling

1. Check all connections for tightness. Open hot water tap furthest away from the OSO water heater.
2. Open the mains stop cock to fill the water heater. When water flows evenly from tap, allow to run for a few minutes to flush through any dirt, swarf or residue, then close the tap. Open successive hot taps to purge any remaining air.
3. Check all water connections for leaks and rectify if necessary.
4. Manually operate Expansion relief valve (6) (see illustration on previous page) to ensure free water flow through discharge pipe by turning knob counter-clockwise. To close continue to turn counter-clockwise until the valve shuts.
5. Manually operate Temperature and Pressure Relief Valve (8) (see illustration on previous page) to ensure free water flows through discharge pipe (Turn knob counter-clockwise).
6. Switch electrical power on.
7. Replace the cylinder lid – this is important as the lid prevents heat loss from the cylinder and combination valve, conserving valuable energy. Do not place heavy objects on the lid.

3.2 Draining

Switch off the electrical power (important to avoid damage to element). Turn off the cold water supply valve. Open hot water tap. Open drain at base of cylinder using a 6 mm hex key. The unit will drain. Draining process may be speeded up by opening the temperature and pressure relief valve. An internal $\varnothing 18$ mm hose can be applied to bottom drain cock to lead the water to a gully, sink or similar.

3.3 System flushing

System flushing will not be necessary under normal circumstances as the line strainer will prevent ingress of foreign materials, however if flushing is required, run at least 50 litres of water from the cylinder at the highest possible flowrate. Close the taps and follow draining procedure above.

4. ELECTRICAL INSTALLATION

4.1 Immersion heaters

Power to immersion heaters should not be switched on until the unit is filled with water. All units are fitted with 2 no. 3 kW immersion heaters except SX 120 which has 1 no. 3kW immersion heater.

Immersion heaters must be wired through the factory fitted thermostat and thermal cut-out according to diagram on the reverse of the electrical box cover.

Alternative thermostats should not be used, regulations require immersion heaters on unvented cylinders to be connected with a thermal cut-out. Recommended torque is 0,2 kp (20Nm). End terminal must not exceed 10 mm, see illustration.

4.2 Wiring of immersion heaters

Follow the wiring instructions connecting the live, neutral and earth as indicated. A dedicated permanent supply complying with current IEE regulations should be used, and each circuit must be protected by a suitable fuse and double pole isolating switch with a contact separation of at least 3 mm in both poles.

All cables should comply with BS6141 table 8 HOFR 85c.

All internal wiring is factory mounted.

A safety cut-out is also incorporated within the upper thermostat and will operate at $85^{\circ}\text{C} \pm 3^{\circ}\text{C}$. Should this happen, check reasons for thermal cut-out button being released and when satisfied press the reset button. Important: Before resetting the safety cut-out or altering the thermostat setting, isolate electrical supply to the unit prior to removal of the lid. Ensure the lid to the electrical box is replaced correctly and the retaining screw is fitted.

Bottom immersion: The 80323 thermostat for 120 litre and 80322 thermostat for all other sizes with embedded iQ Smart Technology has been designed for compliance with European regulations newly introduced for Electric Storage Water Heater (ESWH) efficiency and energy saving. The thermostat has a wide range of configurations to provide the maximum flexibility with the OSO Sole 109 blending valve. The 80322/3 configuration maximizes efficiency improvement and provides all mandatory smart control features.

The unit must be connected to a minimum 16 amp dedicated permanent supply complying with current I.E.E Wiring regulations, isolation is required via a minimum 20 amp double pole iso-

lation switch with a minimum 3 mm separation required. All electrical wiring should be carried out by a competent electrician, using a heat resistant cable (minimum 85°C), and be in accordance with the latest I.E.E Wiring Regulations.

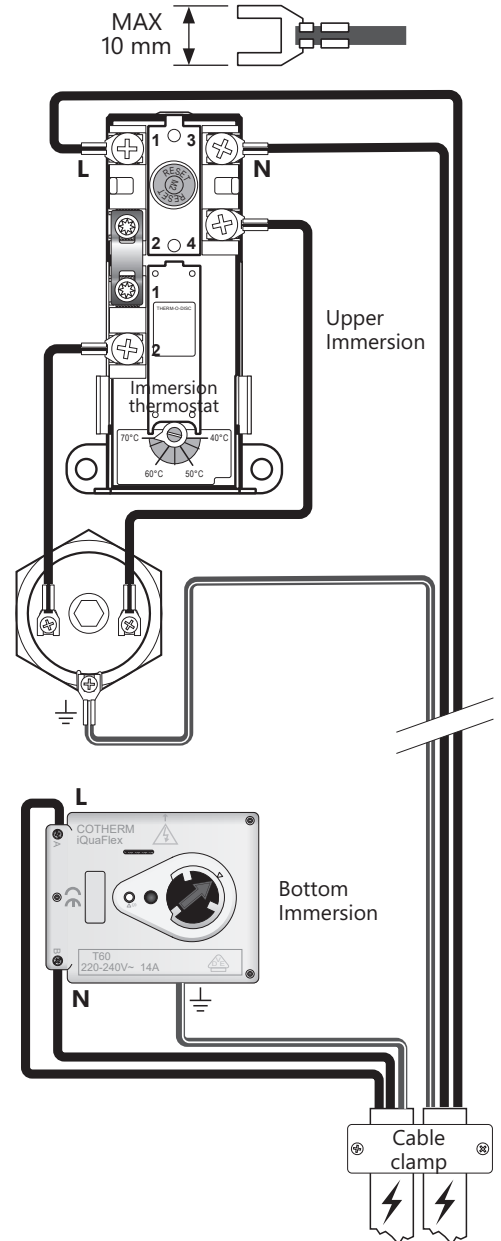

Conductor length - wire stripping

When connecting electric wires to the iQ thermostat the recommended conductor length is 12 mm +/- 1 mm - for Live and Neutral, and 20 mm +/- 1 mm for earth, see illustration (right). Wire terminal screws (A and B) should be tightened to 0,6 Nm +/- 0,1 Nm.

Cutting the cable wires to the lengths shown will allow the thermostat to be removed without disconnection of the live and Neutral wires.

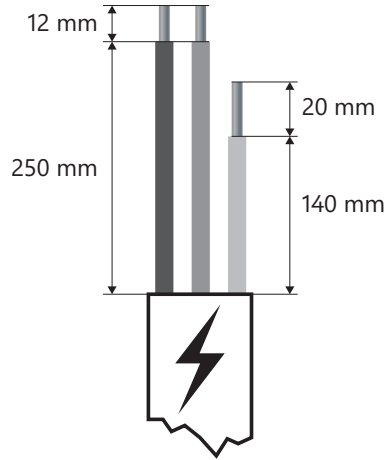

4.3 Smart Control settings

The rotating knob allows selection of desired comfort level, factory default setting is Smart +.

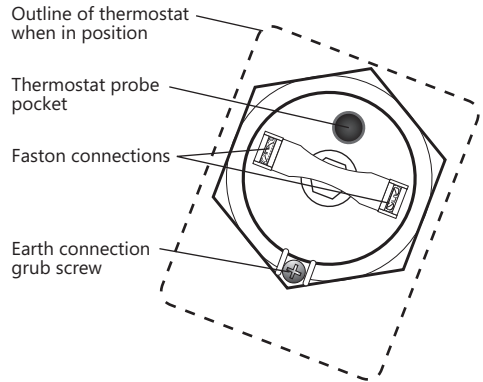
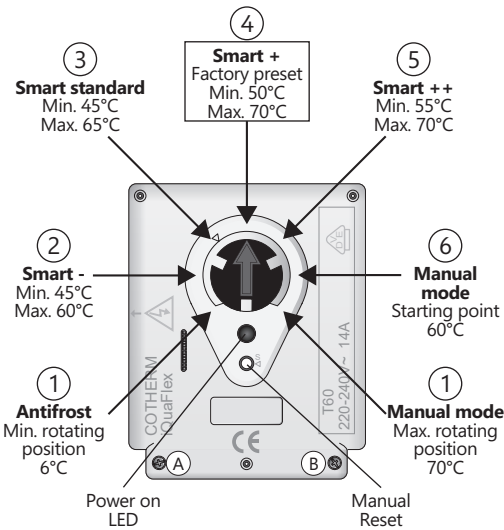

Further to the initial installation, end-users or installers may select a different position if the factory preset position doesn't meet hot water expectations. The factory default position, designated by a small arrow on the top cover, is the recommended position for usage after water heater installation. This position is the setting applied to determine the energy label in conformance with ecolabelling European directive.

Electrical connectors:

Connector	Description
A	Live connection
B	Neutral connection
Earth	Connects to grub screw on element head

Program overview

Position	Label	Description	Temperature
1	Antifrost/vacation	Prevent water freezing	6°C
2	Smart -	Energy saving: Automatically adjust volume of hot water ability based on past consumption	From 45°C to 60°C
3	Smart	Energy saving: Automatically adjust volume of hot water ability based on past consumption	From 45°C to 65°C
4	Smart + (default)	Energy saving: Automatically adjust volume of hot water ability based on past consumption	From 50°C to 70°C
5	Smart ++	Energy saving: Automatically adjust volume of hot water ability based on past consumption	From 55°C to 70°C
6	Manual	Continuous manual temperature setting	60°C
7	Manual	Continuous manual temperature setting	70°C

4.4 Smart Technology

Smart Control for water heaters will save energy and money for consumers by adapting the energy used to the typical household requirements for water heating. When the water heater is first switched on, the smart control operates like a normal thermostat for 7 days, but during this time, will monitor and learn the habits of the household. After 7 days the smart control will reduce the energy used by the water heater to match the requirements of the household. The smart system stays in learning mode and will alter the energy usage in accordance with changes in household hot water usage. 80322/3 includes embedded software with a high performance algorithm which has been tested and approved in both laboratories and in field conditions. The algorithm has been also tested as per the procedure defined in prEN50440. 80322/3

Thermostat software implements a self setting algorithm which is performed at first power ON and repeated throughout the product life whenever there is a need for product performances optimization. This automatic setting determines a set of parameters in direct relationship with the power of the heating element and the tank capacity.

The Smart Thermostat is designed to be directly plugged into an immersion heating element and includes:

- Mechanical double pole disk safety
- Safety limiter set between 65°C and 90°C depending on ESWH
- Manual reset safety
- LED indicator : Power, Error, Warm-up
- 2 pins connector for remote LED (not used)
- Rotating knob for product setting
- Smart Sensor
- Horizontal or Vertical mounting
- Riveted tamper proof cover
- Screw pillar terminals
- Anti-Legionella function
- 14A / 220V – 240V / 50 Hz / 3000 W max.

4.5 Smart Control red LED indicator

The red LED on the top cover of 80322/3 Thermostat Standalone provides information about product status as described in the table (right).

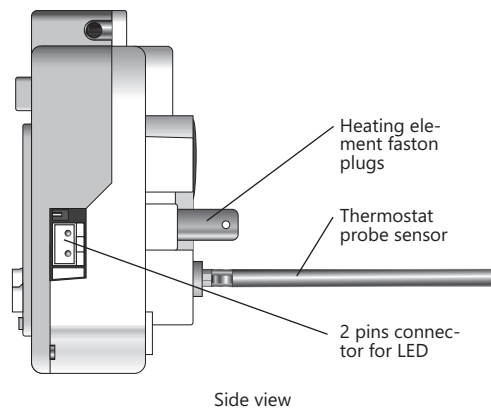
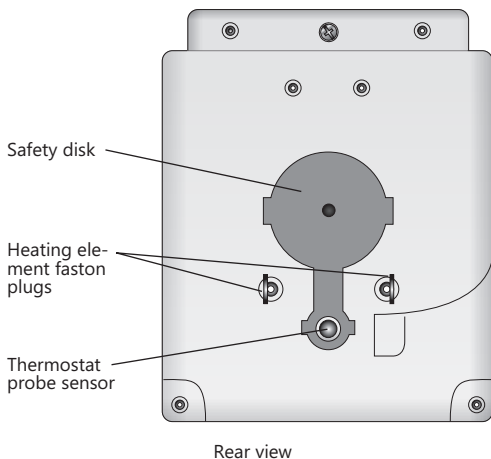

LED mode	Description	Indication
Off	Off full time, or desired temperature is achieved	Product is in OFF mode or fully heated
Blinking every 10 sec.	OFF for 10s and ON for 1s	Product is ready and in normal operation
Solid ON	Full time ON	In normal operation - heating up in progress
Fast blinking	OFF for 1s and ON for 1s	Fault detected (see 'Causes of potential defects
Fast double blinking at start	2 times, OFF for 0.5s and ON for 0.5s	Confirmation of factory preset position of the rotating knob

4.6 Software Reset

A software reset is required after any error detection. To perform a software reset, switch the main power supply of the water heater off, select the vacation antifrost position and switch the power back on. After a software reset smart and comfort level can be selected by rotating the knob. OSO recommends selection of the Smart factory preset position.

4.7 Anti Legionella cycle

The anti-legionella cycle reduces the risk of development of bacteria in the water stored inside the tank. When the water heater is installed and in operation a process will permanently monitor the water temperature. The process is applicable in all modes.

Whenever risk conditions are detected that might cause the development of bacteria, the 80322/3 thermostat will automatically perform full water heat cycle above 65°C.

4.8 Smart Control OFF PEAK function

The 80322/3 thermostat can support smart function in off-peak installation configuration. The 80322/3 thermostat will automatically detect the installation in Off-peak configuration based on presence or absence of power supply during a day. In smart mode, the controller will self manage the adaptation of the algorithm to enable the smart energy saving. During power-off periods, the red LED indicator is turned off.

4.9 Smart Control Power Supply

Power supply has been designed to cover a wide range of voltages and operating conditions, the 80322/3 thermostat operates from 195Vac to 275Vac.

A minimum space clearance is requested to avoid ambient overheat. A minimum of 5 mm from the top cover and 10 mm from the side of the product are recommended.

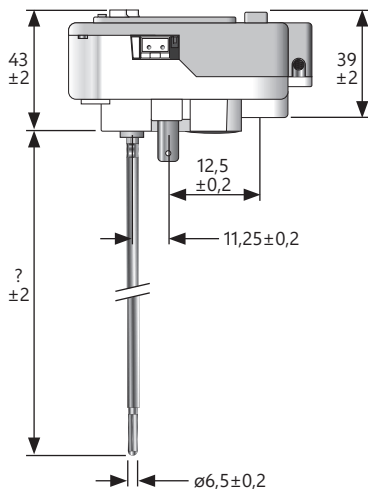
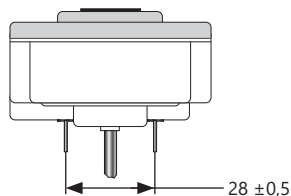
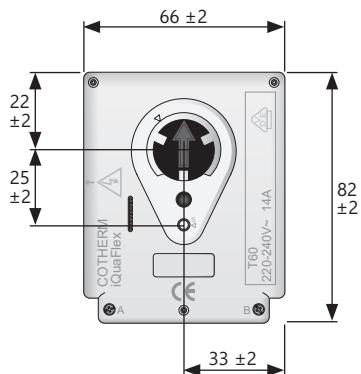

4.10 Smart Control - Technical Data

Items	Description
Product purpose	Energy controller for Electric Storage Water Heater including thermal safety cut-off
Product construction	Hybrid control including electronic regulation and mechanical safety cut-out: 2-pole bimetal cut-out
Terminal type	Power terminals: screw pillar terminal
Method of connection & disconnection	Faston connector to Heating Elements
Wiring type	Power : Power connection to pillar terminal are suitable for the range of wires as mentioned in Table 10.1.4 of EN 60730-1
Method for mounting	OEM manufacturers of ESWH ensure that this product will have dedicated space in respect with product size. A clearance of 5mm from top cover and 10 mm from each side of the product are recommended
Manual reset cut-out	Manual reset of safety cut out can be applied after a minimum of 30°C drop in tank temperature
Action	Thermostat 1.B ; thermal cut-out 2.B
Extent of sensing elements	Smart sensor regulation + 1 disk safety cut-off
Rate impulse voltage	2500V
Light connector	Male XH-2 connector
Light connector, max. current	Forward voltage 3.2V for 20mA
Maximum power of electric heating element supported	2.8 kW @ 230V / 3.0 kW @ 240V
Maximum current Amp.	14 A
Max. ambient temperature operation	60°C
Thermostat temperature range	5°C - 70°C
Thermal cut-out	78°C ± 3°C for 120 litre - 85°C ± 3°C for 150 - 300 litre
Heat and fire resistance category	D
Horizontal heating elements	Yes
Vertical heating elements	Yes
Horizontal water heater	Yes
Vertical water heater	Yes
Lever control	No
Smart off peak	Yes
Power supply max cut off	20 h
Water heater size	120-300
Ambient temperature	60°C
Temperature regulation	5°C - 70°C
Switching capacity	65°C - 90°C

5. SAFETY AND SERVICING

Maintenance must be carried out by a competent person.

5.1 Safety cut out

1. The safety cut-out operates if:
 - a. Wiring is incorrect.
 - b. The immersion heater thermostat or cylinder thermostat fails.
2. Remember before resetting the safety cut-out or altering the thermostat setting, isolate electrical supply to the unit prior to removal of the electrical box lid
3. Reduce thermostat setting and press the reset button. After adjustments are completed, ensure the lid to the electrical box is replaced correctly and the retaining screw is fitted
4. If still out of operation, contact installer.

5.2 Intermittent or slow discharge from tundish

1. Turn off the electrical supply to the immersion heaters.
2. Turn off cold water supply valve.
3. Open a hot tap.
4. Turn the knob on the Temperature and Pressure Relief Valve (C) to the left and hold in this position for 30 seconds
5. Check pre-charge on vessel and adjust pressure if necessary.
6. Open cold water supply valve.
7. When water flows through open tap, close tap. Turn on electrical supply to the immersion heaters.

5.3 Continuous very hot water discharge from tundish

This indicates a malfunction of a thermal cut-out, operating thermostat or the combined temperature and pressure relief valve. Turn off the electrical supply to the immersion heater and also isolate an indirect unit from the boiler. Contact the installer or competent engineer.

5.4 Expansion vessel maintenance

The expansion vessels do not require annual maintenance and should not be tampered with unless an intermittent or slow discharge from the tundish occurs when water is being heated. In this situation, maintenance must be carried out by a competent person and the precharge pressure must be restored to the original value. An annual visual inspection is recommended. Important: to check the precharge the expansion vessel must

be completely empty of water. If the pressure is different from the value shown on the label it must be restored to the original value.

Do not remove expansion vessel without depressurising the cylinder and draining 10 litres of water from the drain valve at the base of the cylinder

5.5 Guarantee

Cylinder should be serviced annually (as below) and logbook should be updated in order to validate guarantee. Logbook and service records act as guarantee document. For terms of guarantee see Service logbook at rear of manual.

5.6 Service procedure

The following maintenance work has to be carried out annually by a competent person:

1. Inspection of pressure/temperature relief valve and expansion relief valve.
2. Manually operate each valve by twisting the operating cap, and check if water flows unobstructed via the tundish to the discharge point.
3. Ensure that both valves re-seat satisfactorily.
4. Visual inspection of expansion vessel.
5. Turn off mains water supply and open nearest hot water tap to depressurise the DHW system.
6. Check the expansion vessel charge with a pressure gauge at the test point.
7. If the pressure is below 3.0 bar, top up with suitable air pressure pump.
8. Complete the service section of Benchmark/Cylinder Commissioning Checklist included in the inside back pages of these instructions.
9. Remove, clean and replace line strainer.
10. The immersion heater element must be removed for inspection on service after 5 years. The threads must be checked for corrosion. If signs of corrosion are evident, the element must be replaced. Subsequently the element must be removed and examined every 3 years. Failure to do so in areas of aggressive water may result in the element separating from the cylinder with consequential escape of water.
11. Visual inspection of all external valves and fittings.

Continued on next page >>

5.7 Combination valve

The combination valve can be separated into two sections by disconnecting the compression fitting in the middle. The entire valve can be removed by unscrewing from the top connection. When refitting, the valve does not tighten, the seal is created by a double O-ring. To create the seal, the valve should be wound down until it will not go any further, then wound back up less than one full turn to point in the desired direction.

5.8 Drain cock

To remove drain cock, turn off power supply and drain cylinder fully. When cylinder has drained, unscrew rear locking ring behind drain cock (turn clockwise). Pull drain cock off. Reverse procedure to refit drain cock. Locking ring only needs to be hand tight, seal comes from double o-ring.

5.9 Alternative discharge

Discharge pipes should be in metal and dedicated to the unvented cylinder. The pipe should have a continuous fall and should terminate in a safe and visible place. Downward discharges at

low level, i.e. up to 100 mm above external surfaces such as car parks, hard standings, grassed areas etc. are acceptable providing that where children may play or otherwise come into contact with discharges, a wire cage or similar guard is positioned to prevent contact, whilst maintaining visibility. Discharge at high level, i.e. into a metal hopper and metal down pipe with the end of the discharge pipe clearly visible (tundish visible or not) or onto a roof capable of withstanding high temperature discharges of water and 3 m from any plastics guttering system that would collect such discharges (tundish visible). Where a single pipe serves a number of discharges, such as in blocks of flats, the number served should be limited to not more than 6 systems so that any installation discharging can be traced reasonably easily. The single common discharge pipe should be at least one pipe size larger than the largest individual discharge pipe to be connected.

For further information contact your Building Control Office.

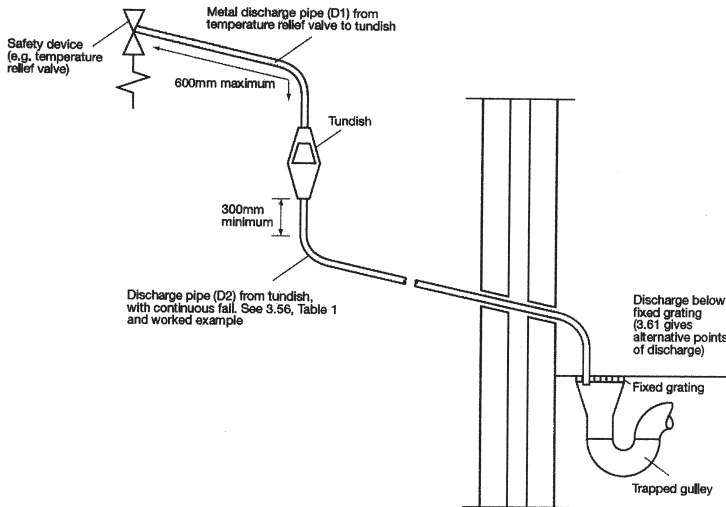

Valve Outlet size	Minimum size of discharge pipe D1	Minimum size of discharge pipe D2 from tundish	Maximum resistance allowed expressed as a length of straight pipe (i.e. no elbow or bends)	Resistance created by each elbow or bend
G 1/2	15 mm	22 mm	up to 9 m	0.8 m
		28 mm	up to 18 m	1.0 m
		35 mm	up to 27 m	1.4 m
G 3/4	22 mm	28 mm	up to 9 m	1.0 m
		35 mm	up to 18 m	1.4 m
		42 mm	up to 27 m	1.7 m
G 1	28 mm	35 mm	up to 9 m	1.4 m
		42 mm	up to 18 m	1.7 m
		54 mm	up to 27 m	2.3 m

6. OSO FAULT FINDING GUIDE

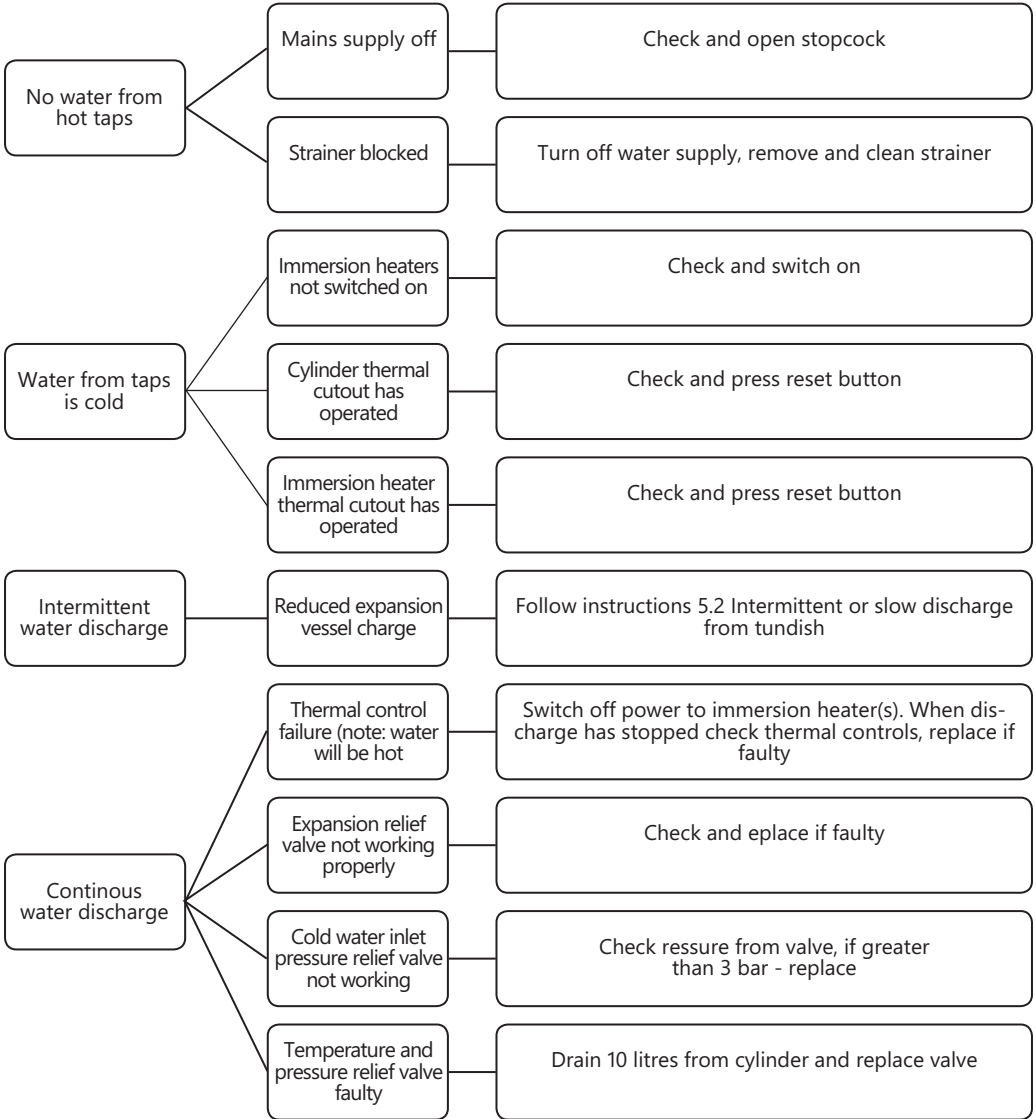

7. TECHNICAL AND PERFORMANCE SPECIFICATIONS

Technical data - SXDiQ

Description	Unit	SXD 120 iQ	SXD 150 iQ	SXD 180 iQ	SXD 210 iQ	SXD 250 iQ	SXD 300 iQ
Part number	-	10802651	10802652	10802653	10802654	10802655	10802656
EAN number	-	7070644005894	7070644005900	7070644005917	7070644005924	7070644005931	7070644005948
Actual capacity of the water tank at 20°C	L.	111	143	164	193	242	280
Outer diameter of the tank	mm	580	580	580	580	580	580
Height of the appliance	mm	870	1050	1160	1300	1550	1750
Gross weight of the appliance	kg	37	42	47	52	59	65
Net weight of appliance once filled with sanitary water	kg	148	185	211	245	301	346
Material of element	-	Titanium	Titanium	Titanium	Titanium	Titanium	Titanium
Thermal insulation material	-	PUR	PUR	PUR	PUR	PUR	PUR
Thermal insulation of the tank, average thickness	mm	35	35	35	35	35	35
IP classification	-	21	21	21	21	21	21
Standby heat losses / 24 hour	kWh/24h	1.03	1.27	1.42	1.56	1.75	2.04
Standby heat losses	Watts	43	53	59	65	73	85
Thermal energy efficiency	%	38.00	38.00	40.00	39.00	39.00	39.00
Annual Electrical Consumption (AEC)	kWh	1336.00	2670.00	2559.00	2641.00	4298.00	4325.00
Load profile	-	M	L	L	L	XL	XL
Hot water capacity(1) >40°C	L.	192	245	279	344	451	490
Primary flowrate for Reheat time & Primary heating power	l/h	900	900	900	900	900	900
Heat up (bottom element) 10°C - max (min)	min	130	174	201	235	297	347
Recovery (bottom element) after 70% (min)	-	91	121	141	165	208	243
Heat up (top element) 10°C - max (min)	min	N/A	74	101	135	132	132
Recovery (top element) after 70% (min)	-	N/A	52	71	95	92	92
ErP class	-	C	C	C	C	C	C
Pressure information							
Maximum design pressure of cylinder (rated pressure)	MPa/Bar	1 / 10	1 / 10	1 / 10	1 / 10	1 / 10	1 / 10
Operating pressure of cylinder	MPa/Bar	3	3	3	3	3	3
Max. operating temperature of cylinder	°C	70	70	70	70	70	70
Expansion solution	-	GWS 3.5bar	GWS 3.5bar	GWS 3.5bar	GWS 3.5bar	GWS 3.5bar	GWS 3.5bar
Expansion vessel capacity	L.	6	2 x 6	2 x 6	2 x 6	2 x 6	24
Hydraulic connections							
Secondary return	mm	15	15	15	15	15	15
Cold water	Inch	3/4"	3/4"	3/4"	3/4"	3/4"	3/4"
Hot water	Inch	3/4"	3/4"	3/4"	3/4"	3/4"	3/4"
Immersion heater	Inch	5/4"	5/4"	5/4"	5/4"	5/4"	5/4"
Safety valve (factory fitted)	Inch	1/2"	1/2"	1/2"	1/2"	1/2"	1/2"
T&P valve (factory fitted)	Inch	1/2"	1/2"	1/2"	1/2"	1/2"	1/2"
Pressure reducing valve	Inch	3/4"	3/4"	3/4"	3/4"	3/4"	3/4"
Electrical characteristics							
Supply voltage and frequency	WHZ	220-240 VAC	220-240 VAC	220-240 VAC	220-240 VAC	220-240 VAC	220-240 VAC
Power of the electrical resistance	kW	3.0kW@240V 2.8kW@230V	3.0kW@240V 2.8kW@230V	3.0kW@240V 2.8kW@230V	3.0kW@240V 2.8kW@230V	3.0kW@240V 2.8kW@230V	3.0kW@240V 2.8kW@230V
Electrical installation	-	IEEE regs	IEEE regs	IEEE regs	IEEE regs	IEEE regs	IEEE regs
Thermostat type - immersion/cylinder	-	Probe/Probe	Probe/Probe	Probe/Probe	Probe/Probe	Probe/Probe	Probe/Probe
Immersion Heater - Phase	Phase	single	single	single	single	single	single
Immersion thermostat - temp range Top	°C	N/A	40-70	40-70	40-70	40-70	40-70
Immersion thermostat - set temp Top	°C	N/A	70	70	70	70	70
Immersion thermostat - temp range Smart	°C	5-70	5-70	5-70	5-70	5-70	5-70
Immersion thermostat - set temp Smart	°C	Smart+	Smart+	Smart+	Smart+	Smart+	Smart+
Safety							
Safety valve opening pressure +/- 5%	Bar	8	8	8	8	8	8
T&P valve opening pressure/Temp.	Bar/°C	10/90	10/90	10/90	10/90	10/90	10/90
Safety thermostat cutout - Top	°C	N/A	85	85	85	85	85
Safety thermostat cutout - Smart	°C	85	85	85	85	85	85

IT IS THE RESPONSIBILITY OF THE INSTALLER TO COMPLETE THIS LOG BOOK AND PASS IT ON TO THE CUSTOMER. FAILURE TO DO SO MAY INVALIDATE THE CYLINDER GUARANTEE



The code of practice for the installation, commissioning & servicing of mains pressure hot water storage

Installation, Commissioning and Service Record Log Book

CUSTOMER DETAILS

NAME	_____
ADDRESS	_____
	TEL No. _____

IMPORTANT

1. Please, keep the Log Book in a safe place for future reference.
2. This Log Book is to be completed in full by the competent person(s) who commissioned the equipment and then handed to the customer. When this is done, the Log Book is a commissioning certificate that can be accepted as evidence of compliance with the appropriate Building Regulations.
3. Failure to install and commission this appliance to the manufacturer's instructions may invalidate the guarantee.

The above does not affect your statutory rights.



© HEATING AND HOTWATER INFORMATION COUNCIL

HWA charter members agree to:

- To supply fit for purpose products clearly and honestly described
- To supply products that meet, or exceed appropriate standards and building and water regulations
- To provide pre and post sales technical support
- To provide clear and concise warranty details to customers

For full details on the HWA charter please visit <http://www.hotwater.org.uk/>

INSTALLER & COMMISSIONING ENGINEER DETAILS

INSTALLER DETAILS

COMPANY NAME	DATE
ADDRESS	
INSTALLER NAME	TEL No.
REGISTRATION DETAILS	
REGISTERED OPERATIVE ID CARD No. (IF APPLICABLE)	

COMMISSIONING ENGINEER (IF DIFFERENT)

NAME	DATE
ADDRESS	
TEL No.	
REGISTRATION DETAILS	
REGISTERED OPERATIVE ID CARD No. (IF APPLICABLE)	

APPLIANCE & TIME CONTROL DETAILS

MANUFACTURER OSO HOTWATER (UK)	MODEL		
CAPACITY	litres	SERIAL No.	
TYPE	UNVENTED		
TIME CONTROL	PROGRAMMER <input type="checkbox"/>	or	TIME SWITCH <input type="checkbox"/>

IT IS THE RESPONSIBILITY OF THE INSTALLER TO COMPLETE THIS LOGBOOK AND PASS IT ON TO THE CUSTOMER. FAILURE TO DO SO MAY INVALIDATE THE CYLINDER GUARANTEE

COMMISSIONING PROCEDURE INFORMATION

BOILER PRIMARY SETTINGS (INDIRECT HEATING ONLY) ALL BOILERS

IS THE PRIMARY A SEALED OR OPEN VENTED SYSTEM? SEALED OPEN
WHAT IS THE BOILER FLOW TEMPERATURE? °C

ALL MAINS PRESSURISED SYSTEMS

WHAT IS INCOMING STATIC COLD WATER PRESSURE AT THE INLET TO THE
PRESSURE REDUCING VALVE? bar
HAS STRAINER (IF FITTED) BEEN CLEANED OF INSTALLATION DEBRIS? YES NO
HAS A WATER SCALE REDUCER BEEN FITTED? YES NO
WHAT TYPE OF SCALE REDUCER HAS BEEN FITTED? _____

UNVENTED SYSTEMS

ARE COMBINED TEMPERATURE AND PRESSURE RELIEF VALVE
AND EXPANSION VALVE FITTED AND DISCHARGE TESTED? YES NO
IS PRIMARY ENERGY SOURCE CUT OUT FITTED
(NORMALLY 2 PORT VALVE)? YES NO
WHAT IS THE PRESSURE REDUCING VALVE SETTING (IF FITTED)? bar
WHERE IS OPERATING PRESSURE REDUCING VALVE SITUATED? YES NO
HAS THE EXPANSION VESSEL OR INTERNAL AIR SPACE BEEN CHECKED? YES NO
WHAT IS THE HOT WATER TEMPERATURE AT THE NEAREST OUTLET? °C

ALL PRODUCTS

DOES THE HOT WATER SYSTEM COMPLY WITH
THE APPROPRIATE BUILDING REGULATIONS? YES
HAS THE SYSTEM BEEN INSTALLED AND COMMISSIONED
IN ACCORDANCE WITH THE MANUFACTURER'S INSTRUCTIONS? YES
HAVE YOU DEMONSTRATED THE OPERATION OF THE
SYSTEM CONTROLS TO THE CUSTOMER? YES
HAVE YOU LEFT ALL THE MANUFACTURER'S
LITERATURE WITH THE CUSTOMER? YES

COMPETENT PERSON'S
SIGNATURE

CUSTOMER'S
SIGNATURE

*(To confirm demonstrations of equipment and
receipt of appliance instructions)*

PLEASE FOLLOW THE INSTALLATION AND COMMISSIONING INSTRUCTIONS
IN THE INSTALLATION MANUAL SUPPLIED WITH THE EQUIPMENT (this document)

GUARANTEE - OSO UNVENTED HOTWATER CYLINDER

1. Scope

OSO Hotwater UK Ltd. (hereinafter called OSO) warrants for 2 years from the date of purchase, that the Product will: i) conform to OSO specification, ii) be free from defects in materials and workmanship, subject to conditions below. All components carry a 2-year warranty.

The warranty is voluntarily extended by OSO to 25 years for the stainless steel inner tank. This extended warranty only applies to Products purchased by a consumer, that has been installed for private use and that has been distributed by OSO or by a distributor where the Products have been originally sold by OSO.

The extended warranty does not apply to Products purchased by commercial entities or for Products that have been installed for commercial use. These shall be subject only to the mandatory provisions of the law. The conditions and limitations set out below shall apply.

2. Coverage

If a defect arises and a valid claim is received within the statutory warranty period, at its option and to the extent permitted by law, OSO shall either: i) repair the defect, or; ii) replace the product with a product that is identical or similar in function, or; iii) refund the purchase price.

If a defect arises and a valid claim is received after the statutory warranty period has expired, but within the extended warranty period, OSO will supply a product that is identical or similar in function. OSO will in such cases not cover any other associated costs. In addition, for every year after the statutory warranty period, the claimant must contribute 4 % of the list price of the cylinder in question to OSO.

Any exchanged Product or component will become the legal property of OSO. Any valid claim or service does not extend the original warranty. The replacement Product or part does not carry a new warranty.

3. Conditions

The Product is manufactured to suit most public water supplies. However, there are certain water chemistries (outlined below) that can have a detrimental effect on the Product and its life expectancy. If there are uncertainties regarding water quality, the local water supply authority can supply the necessary data.

The warranty applies only if the conditions set out below are met in full:

- The Product has been installed by a professional installer, in accordance with the instructions in the installation manual and all relevant Codes of Practice and Regulations in force at the time of installation.
- The Product has not been modified in any way, tampered with or subjected to misuse and no factory fitted parts have been removed for unauthorized repair or replacement.
- The Product has only been connected to a domestic mains water supply in compliance with the European Drinking Water Directive EN 98/83 EC, or latest version. The water should not be aggressive, i.e. the water chemistry shall comply with the following:

- Chloride	< 250 mg / L
- Electric Conductivity (EC) @25°C	< 750 uS / cm
- Saturation Index (LSI) @80°C	> - 1,0 / < 0,8
- pH level	> 6,0 / < 9,5

- The immersion heater has not been exposed to hardness levels exceeding 10°dH (180 ppm CaCO₃). A water softener is recommended in such cases.
- Any disinfection has been carried out without affecting the Product in any way whatsoever. The Product shall be isolated from any system chlorination.
- The Product has been in regular use from the date of installation. If the Product is not intended to be used for 60 days or more, it must be drained.
- The immersion heater element must be removed for inspection on service after 5 years. The threads must be checked for corrosion. If signs of corrosion are evident, the element must be replaced. Subsequently the element must be removed and examined every 3 years. Failure to do so in areas of aggressive water may result in the element separating from the cylinder with consequential escape of water.
- Service and/or repair shall be done according to the installation manual and all relevant codes of practice. Any replacement parts used shall be original OSO spare parts.
- The Service record / Benchmark logbook has been completed and updated after each annual service. Invoices should be kept as proof of service.
- The Commissioning Checklist / Benchmark certificate has been completed at the time of installation.
- Any third-party costs associated with any claim has been authorized in advance by OSO in writing.
- The purchase invoice and/or installation invoice, a water sample as well as the defective product is made available to OSO upon request.

Failure to follow these instructions and conditions may result in product failure, and water escaping from the Product.

4. Limitations

The warranty does not cover:

- Any fault or costs arising from incorrect installation, incorrect application, lack of regular maintenance in accordance with the installation manual, neglect, accidental or malicious damage, misuse, any alteration, tampering or repair carried out by a non-professional, any fault arising from the tampering with or removal of any factory fitted safety components or measures.
- Any consequential damage or any indirect loss caused by any failure or malfunction of the Product whatsoever.
- Any pipework or any equipment connected to the Product.
- The effects of frost, lightning, voltage variation, lack of water, dry boiling, excess pressure or chlorination procedures.
- The effects of stagnant (de-aerated) water if the Product has been left unused for more than 60 days consecutively.
- Damage caused during transportation. Buyer shall give the carrier notice of such damage.
- Costs arising if the Product is not immediately accessible for servicing.

These warranties do not affect the Buyer's statutory rights.

8.1 Customer service

In case of problems that cannot be resolved with the aid of the troubleshooting guide in this installation manual, contact either:

A) The installer who supplied the product.

B) OSO Hotwater UK Limited:

Tel.: (0191) 482 0800 Fax: (0191) 491 3655

Email: technical.uk@oso-hotwater.com

9. REMOVING THE PRODUCT

9.1 Removal

A) Disconnect the power supply.

B) Shut off incoming cold water supply.

C) Empty the product of water – see section 4.4.

D) Disconnect all pipes.

E) The product can now be removed.

9.2 Returns scheme

This product is recyclable and should be taken to the environmental recycling centre. If the product is to be replaced with a new one, the installer can take the old cylinder away for recycling.

SERVICE INTERVAL RECORD

It is recommended that your hot water system is serviced regularly and that your service engineer completes the appropriate Service Interval Record below.

SERVICE PROVIDER

Before completing the appropriate Service Interval Record below, please ensure you have carried out the service as described in the manufacturer's instructions and in compliance with all relevant codes of practice.

SERVICE 1	DATE:
ENGINEER NAME	_____
COMPANY NAME	_____
TEL No.	_____
COMMENTS	_____
SIGNATURE	_____

SERVICE 2	DATE:
ENGINEER NAME	_____
COMPANY NAME	_____
TEL No.	_____
COMMENTS	_____
SIGNATURE	_____

SERVICE 3	DATE:
ENGINEER NAME	_____
COMPANY NAME	_____
TEL No.	_____
COMMENTS	_____
SIGNATURE	_____

SERVICE 4	DATE:
ENGINEER NAME	_____
COMPANY NAME	_____
TEL No.	_____
COMMENTS	_____
SIGNATURE	_____

SERVICE 5	DATE:
ENGINEER NAME	_____
COMPANY NAME	_____
TEL No.	_____
COMMENTS	_____
SIGNATURE	_____

SERVICE 6	DATE:
ENGINEER NAME	_____
COMPANY NAME	_____
TEL No.	_____
COMMENTS	_____
SIGNATURE	_____

SERVICE 7	DATE:
ENGINEER NAME	_____
COMPANY NAME	_____
TEL No.	_____
COMMENTS	_____
SIGNATURE	_____

SERVICE 8	DATE:
ENGINEER NAME	_____
COMPANY NAME	_____
TEL No.	_____
COMMENTS	_____
SIGNATURE	_____

SERVICE 9	DATE:
ENGINEER NAME	_____
COMPANY NAME	_____
TEL No.	_____
COMMENTS	_____
SIGNATURE	_____

SERVICE 10	DATE:
ENGINEER NAME	_____
COMPANY NAME	_____
TEL No.	_____
COMMENTS	_____
SIGNATURE	_____

When all the above services have been completed, please contact your Service Engineer for an additional service interval record sheet.



OSO Hotwater (UK) Limited

Endeavor House, Seventh Avenue,
Team Valley Trading Estate,
Gateshead,
Tyne & Wear,
NE11 0EF
Phone: (0191) 482 0800 Fax: (0191) 491 3655
E-mail technical.uk@oso-hotwater.com
E-mail spareparts.uk@oso-hotwater.com
E-mail sales.uk@oso-hotwater.com

OSO Hotwater AS

Industriveien 1
3300 Hokksund - Norway
Tel.: +47 32 25 00 00
oso@oso.no
www.osohotwater.com

© Alle deler av denne montasjeanvisningen er beskyttet av åndsverksloven og skal ikke reproduseres eller distribueres uten skriftlig avtale med produsenten. Forandringer forbeholdes.

© This installation manual and all its content is protected by copyright and may be reproduced or distributed only with written consent from the manufacturer. We reserve the right to make changes without notice.