



BUILT-IN OVEN

USER INSTRUCTIONS

GEBM45003B

EN

www.grundig.com

FOR A GOOD REASON

GRUNDIG

285.4457.81/R.AA/22.08.2017

Please read this user manual first!

Dear Customer,

Thank you for purchasing this Grundig product. We hope that you get the best results from your product which has been manufactured with high quality and state-of-the-art technology. Therefore, please read this entire user manual and all other accompanying documents carefully before using the product and keep it as a reference for future use. If you handover the product to someone else, give the user manual as well. Follow all warnings and information in the user manual.

Remember that this user manual is also applicable for several other models. Differences between models will be identified in the manual.

Explanation of symbols

Throughout this user manual the following symbols are used:

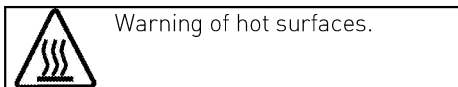
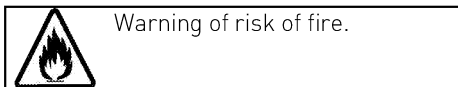
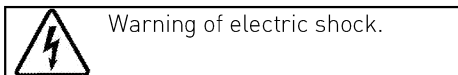
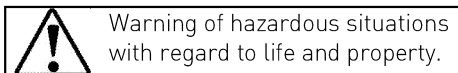
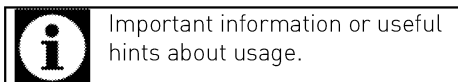

TABLE OF CONTENTS

1 Important instructions and warnings for safety and environment 4

General safety.....	4
Electrical safety.....	5
Product safety.....	6
Intended use	8
Safety for children	8
Disposing of the old product.....	9
Package information.....	9

2 General information 10

Overview.....	10
Package contents.....	11
Technical specifications.....	12

3 Installation 13

Before installation.....	13
Appliance built-under of the hob and oven configuration.....	16
Installation and connection	17
Future Transportation.....	19

4 Preparation 20

Tips for saving energy	20
Initial use	20
Day time	20
First cleaning of the appliance....	21
Initial heating.....	21

5 How to operate the oven 23

General information on baking, roasting and grilling	23
How to operate the electric oven.	24
Operating modes	26
How to operate the oven control unit.....	29
Using the keylock	32
Using the clock as an alarm	33
Cooking times table.....	33
Settings menu.....	36
How to operate the grill	37
Cooking times table for grilling ..	37

6 Maintenance and care 38

General information	38
Cleaning the control panel.....	38
Cleaning the oven	38
Removing the oven door.....	40
Removing the door inner glass....	41
Replacing the oven lamp.....	42

7 Troubleshooting 43

8 Guarantee Details 44

1 Important instructions and warnings for safety and environment

This section contains safety instructions that will help protect from risk of personal injury or property damage. Failure to follow these instructions shall void any warranty.

General safety

- This appliance can be used by children aged from 8 years and above and persons with reduced physical, sensory or mental capabilities or lack of experience and knowledge if they have been given supervision or instruction concerning use of the appliance in a safe way and understand the hazards involved.
Children shall not play with the appliance. Cleaning and user maintenance shall not be made by children without supervision.
- The appliance is not to be used by persons (including children) with reduced physical, sensory or mental capabilities, or lack of experience and knowledge, unless they have been given supervision or instruction.
Children should be supervised and ensure they do not play with the appliance
- If the product is handed over to someone else for personal use or second-hand use purposes, the user manual, product labels and other relevant documents and parts should be also given.
- Installation and repair procedures must always be performed by Authorised Service Agents. The manufacturer shall not be held responsible for damages arising from procedures carried out by unauthorised persons which may also void the warranty. Before

installation, read the instructions carefully.

- Do not operate the product if it is defective or has any visible damage.
- Ensure that the product function knobs are switched off after every use.

Electrical safety

- If the product has a failure, it should not be operated unless it is repaired by an Authorised Service Agent. There is the risk of electric shock!
- Only connect the product to a grounded outlet/line with the voltage and protection as specified in the “Technical specifications”. Have the grounding installation made by a qualified electrician while using the product with or without a transformer. Our company shall not be liable for any problems arising due to the product not being earthed in accordance with the local regulations.
- Never wash the product by spreading or pouring water

onto it! There is the risk of electric shock!

- The product must be disconnected during installation, maintenance, cleaning and repairing procedures.
- If the power connection cable for the product is damaged, it must be replaced by the manufacturer, its service agent or similarly qualified persons in order to avoid a hazard.
- Only use the connection cable specified in the “Technical specifications”.
- The appliance must be installed so that it can be completely disconnected from the mains supply. The separation must be provided by a switch built into the fixed electrical installation, according to construction regulations.
- Rear surface of the oven gets hot when it is in use. Make sure that the electrical connection does not contact the rear surface; otherwise,

connections can get damaged.

- Do not trap the mains cable between the oven door and frame and do not route it over hot surfaces. Otherwise, cable insulation may melt and cause fire as a result of short circuit.
- Any work on electrical equipment and systems should only be carried out by authorised and qualified persons.
- In case of any damage, switch off the product and disconnect it from the mains. To do this, turn off the fuse at home.
- Make sure that fuse rating is compatible with the product.

Product safety

- **WARNING:** The appliance and its accessible parts become hot during use. Care should be taken to avoid touching heating elements. Children less than 8 years of age shall be kept away unless continuously supervised.
- Never use the product when your judgment or

coordination is impaired by the use of alcohol and/or drugs.

- Be careful when using alcoholic drinks in your dishes. Alcohol evaporates at high temperatures and may cause fire since it can ignite when it comes into contact with hot surfaces.
- Food Poisoning Hazard: Do not let food sit in oven for more than 1 hour before or after cooking. Doing so can result in food poisoning or sickness.
- Do not place any flammable materials close to the product as the sides may become hot during use.
- During use the appliances becomes hot. Care should be taken to avoid touching heating elements inside the oven.
- Keep all ventilation slots clear of obstructions.
- Do not heat closed tins and glass jars in the oven. The pressure that would build-up in the tin/jar may cause it to burst.

- Do not place baking trays, dishes or aluminium foil directly onto the bottom of the oven. The heat accumulation might damage the bottom of the oven.
- Do not use harsh abrasive cleaners or sharp metal scrapers to clean the oven door glass since they can scratch the surface, which may result in shattering of the glass.
- Do not use steam cleaners to clean the appliance as this may cause an electric shock.
- **(Varies depending on the product model.)**

Placing the wire shelf and tray onto the wire racks properly

It is important to place the wire shelf and/or tray onto the rack properly. Slide the wire shelf or tray between 2 rails and make sure that it is balanced before placing food on it (Please see the following figure).

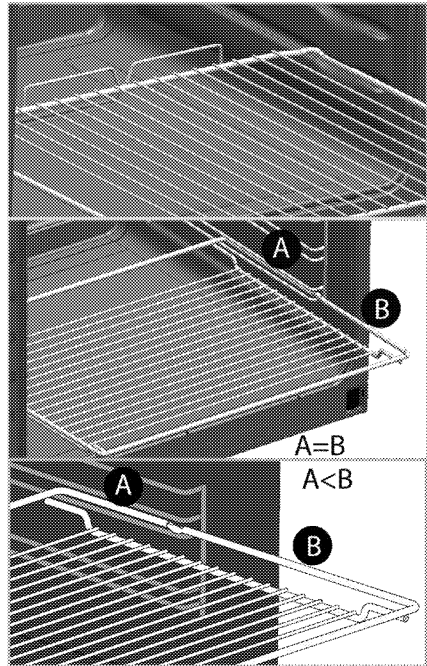

- Do not use the product if the front door glass removed or cracked.
- Do not use the oven handle to hang towels for drying. Do not hang up towel, gloves, or similar textile products when the grill function is at open door.
- Always use heat resistant oven gloves when putting in or removing dishes into/from the hot oven.
- Place the baking paper into the cooking pot or on to the oven accessory (tray, wire grill etc) together with the food and then insert all into

the preheated oven.
Remove the excess parts of the baking paper overflowing from the accessory or the pot in order to prevent the risk of touching the oven's heating elements. Never use the baking paper in an operating temperature higher than the indicated value for the baking paper. Do not place the baking paper directly on the base of the oven.

- **WARNING:** Ensure that the appliance is switched off before replacing the lamp to avoid the possibility of electric shock.
- The appliance must not be installed behind a decorative door in order to avoid overheating.
- Product must be placed directly on the floor. It must not be placed onto a base or a pedestal.

Prevention against possible fire risk!

- Ensure all electrical connections are secure and tight to prevent risk of arcing.

- Do not use damaged cables or extension cables.
- Ensure liquid or moisture is not accessible to the electrical connection point.

Intended use

- This product is designed for domestic use. Commercial use will void the guarantee.
- This appliance is for cooking purposes only. It must not be used for other purposes, for example room heating.
- This product should not be used for warming the plates under the grill, drying towels, dish cloths etc. by hanging them on the oven door handles. This product should also not be used for room heating purposes.
- The manufacturer shall not be liable for any damage caused by improper use or handling errors.
- The oven can be used for defrosting, baking, roasting and grilling food.

Safety for children

- **WARNING:** Accessible parts may become hot

during use. Young children should be kept away.

- The packaging materials will be dangerous for children. Keep the packaging materials away from children. Please dispose of all parts of the packaging according to environmental standards.
- Electrical products are dangerous to children. Keep children away from the product when it is operating and do not allow them to play with the product.
- Do not place any items above the appliance that children may reach for.
- When the door is open, do not load any heavy object on it and do not allow children to sit on it. It may overturn or door hinges may get damaged.

**Disposing of the old product
Compliance with the WEEE
Directive and Disposing of the
Waste Product:**



This product complies with EU WEEE Directive (2012/19/EU). This product bears a classification symbol for waste electrical and electronic equipment (WEEE). This product has been manufactured with high quality parts and materials which can be reused and are suitable for recycling. Do not dispose of the waste product with normal domestic and other wastes at the end of its service life. Take it to the collection center for the recycling of electrical and electronic equipment. Please consult your local authorities to learn about these collection centers.

Compliance with RoHS Directive:

The product you have purchased complies with EU RoHS Directive (2011/65/EU). It does not contain harmful and prohibited materials specified in the Directive.

Package information

- Packaging materials of the product are manufactured from recyclable materials in accordance with our National Environment Regulations. Do not dispose of the packaging materials together with the domestic or other wastes. Take them to the packaging material collection points designated by the local authorities.

2 General information

Overview

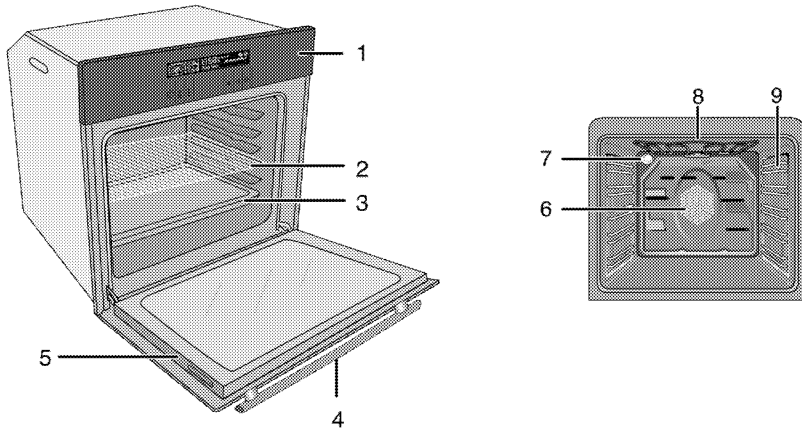

- | | | | |
|---|---------------|---|--------------------------------|
| 1 | Control panel | 6 | Fan motor (behind steel plate) |
| 2 | Wire shelf | 7 | Lamp |
| 3 | Tray | 8 | Top heating element |
| 4 | Handle | 9 | Shelf positions |
| 5 | Front door | | |

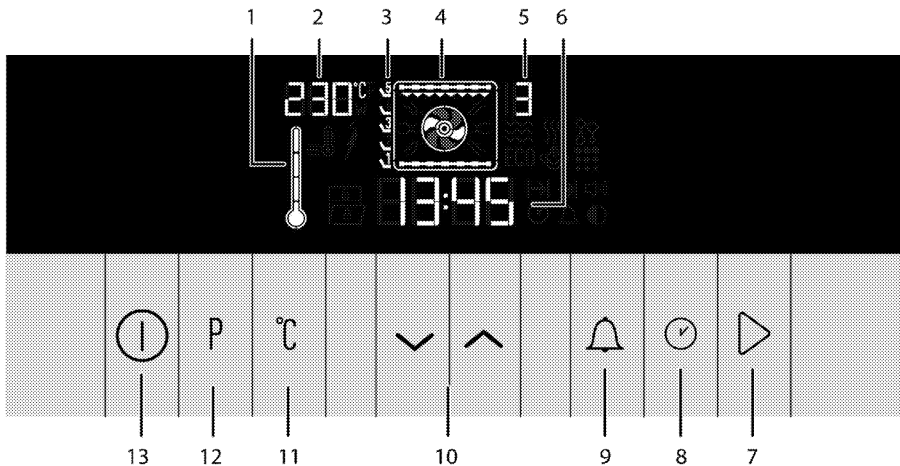

- | | | | |
|---|-------------------------------|----|---------------------------------|
| 1 | Oven Inner Temperature symbol | 8 | Time and settings key |
| 2 | Temperature indicator field | 9 | Alarm key |
| 3 | Shelf positions | 10 | Up/down keys (Menu step) |
| 4 | Function display | 11 | Temperature/booster setting key |
| 5 | Function number | 12 | Return Key to function display |
| 6 | Current time indicator field | 13 | ON/OFF key |
| 7 | Start/stop cooking key | | |

Package contents



Accessories supplied can vary depending on the product model. Not every accessory described in the user manual may exist on your product.

1. User manual

2. Oven tray

Used for pastries, frozen foods and big roasts.

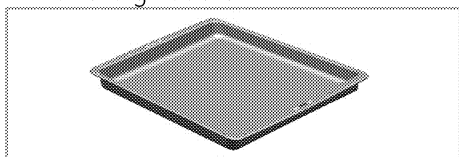

3. Pastry tray

Used for pastries such as cookies and biscuits.

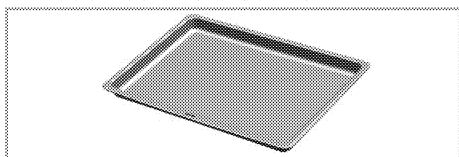

4. Wire Shelf

Used for roasting and for placing the food to be baked, roasted or cooked in casserole dishes to the desired rack.

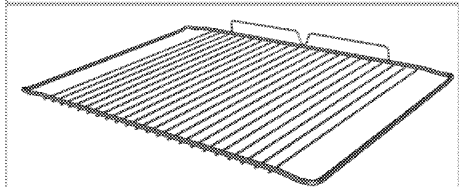
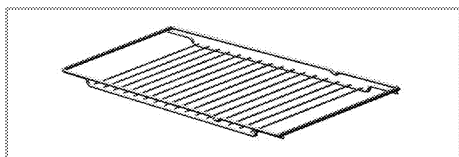

5. Small wire shelf

It is placed into the tray (if supplied) in order to collect the

dripping fat while grilling so that the oven is kept clean.

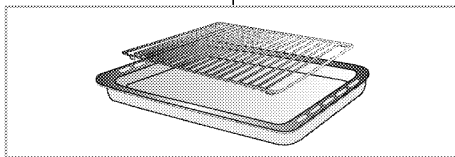

6. Placing the wire shelf and tray onto the telescopic racks properly

(This feature is optional. It may not exist on your product.)

Telescopic racks allow you to install and remove the trays and wire shelf easily.

When using the tray and wire shelf with telescopic racks, make sure that the pins at the rear section of the telescopic rack stands against the edges of the wire shelf and tray.

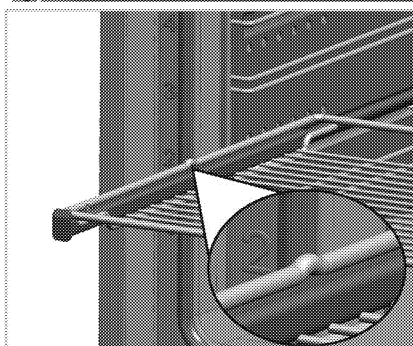
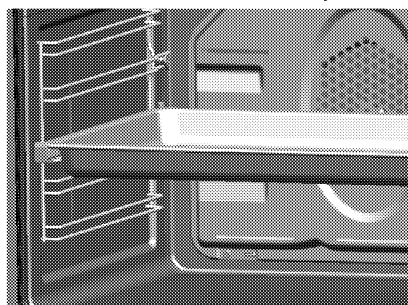

Technical specifications

Voltage / frequency	220-240 V ~ 50 Hz
Total power consumption	3,1kW
Fuse	16 A
Cable type / section	min.H05VV-FG 3 x 1,5 mm ²
External dimensions (height / width / depth)	595 mm/594 mm/567 mm
Installation dimensions (height / width / depth)	**590 or 600 mm/560 mm/min. 550 mm
Main oven	Multifunction oven
Inner lamp	15/25 W
Grill power consumption	2.2 kW

Basics: Information on the energy label of electrical ovens is given in accordance with the EN 60350-1 / IEC 60350-1 standard. Those values are determined under standard load with bottom-top heater or fan assisted heating (if any) functions.

Energy efficiency class is determined in accordance with the following prioritization depending on whether the relevant functions exist on the product or not. 1-Cooking with eco-fan, 2- Turbo slow cooking, 3- Turbo cooking, 4- Fan assisted bottom/top heating, 5-Top and bottom heating.

** See. *Installation, page 13.*



Technical specifications may be changed without prior notice to improve the quality of the product.



Figures in this manual are schematic and may not exactly match your product.



Values stated on the product labels or in the documentation accompanying it are obtained in laboratory conditions in accordance with relevant standards. Depending on operational and environmental conditions of the product, these values may vary.

3 Installation

Product must be installed by a qualified person in accordance with the regulations in force. The manufacturer shall not be held responsible for damages arising from procedures carried out by unauthorized persons which may also void the warranty.



Preparation of location and electrical installation for the product is under the installer's responsibility.



DANGER:

The product must be installed in accordance with all local electrical regulations.



DANGER:

Prior to installation, visually check if the product has any defects on it. If so, do not have it installed. Damaged products cause risks for your safety.

Before installation

The appliances must not be installed behind a decorative door in order to avoid overheating. The appliance is intended for installation in commercially available kitchen cabinets. A safety

distance must be left between the appliance and the kitchen walls and furniture. See figure (values in mm).

- Surfaces, synthetic laminates and adhesives used must be heat resistant (100 °C minimum).
- Kitchen cabinets must be set level and fixed.
- If there is a drawer beneath the oven, a shelf must be installed between oven and drawer.
- Carry the appliance with at least two persons.



Do not install the appliance next to refrigerators or freezers. The heat emitted by the appliance will lead to an increased energy consumption of cooling appliances.



The door and/or handle must not be used for lifting or moving the appliance.



If the appliance has wire handles, push the handles back into the side walls after moving the appliance.

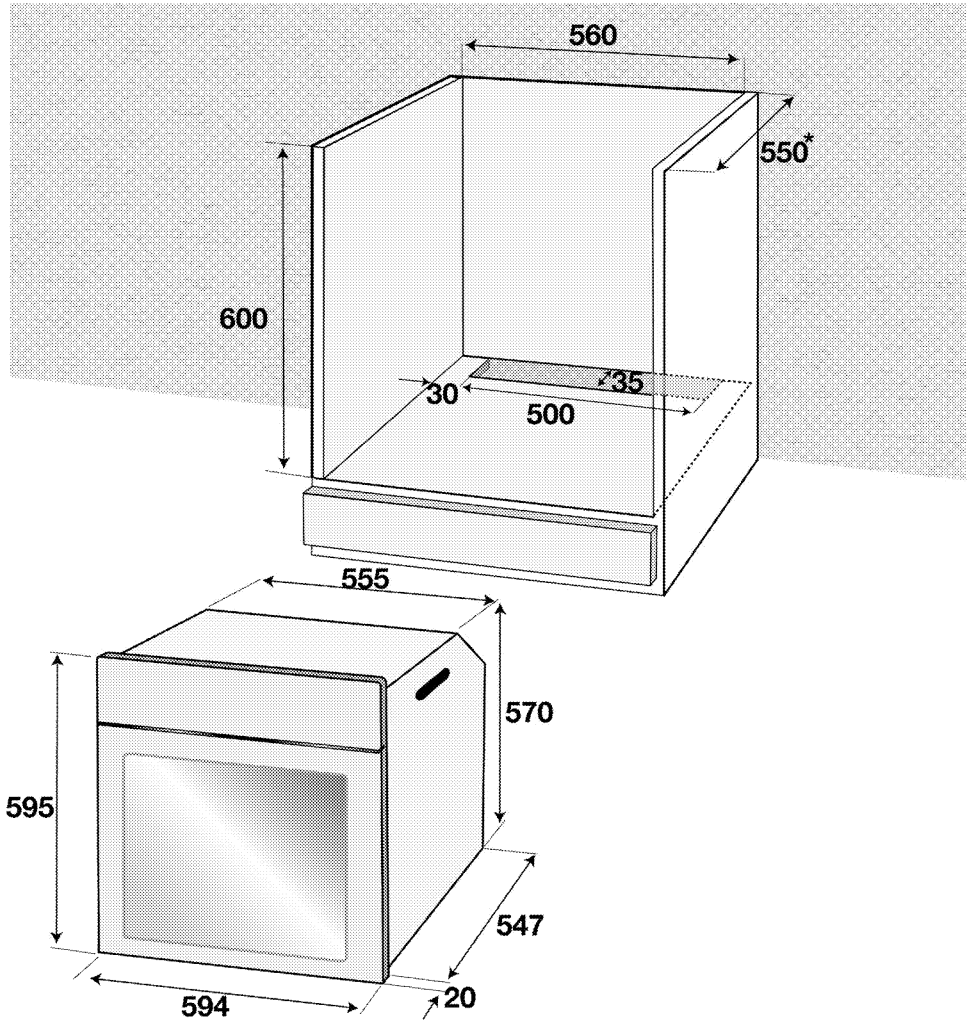

* min.

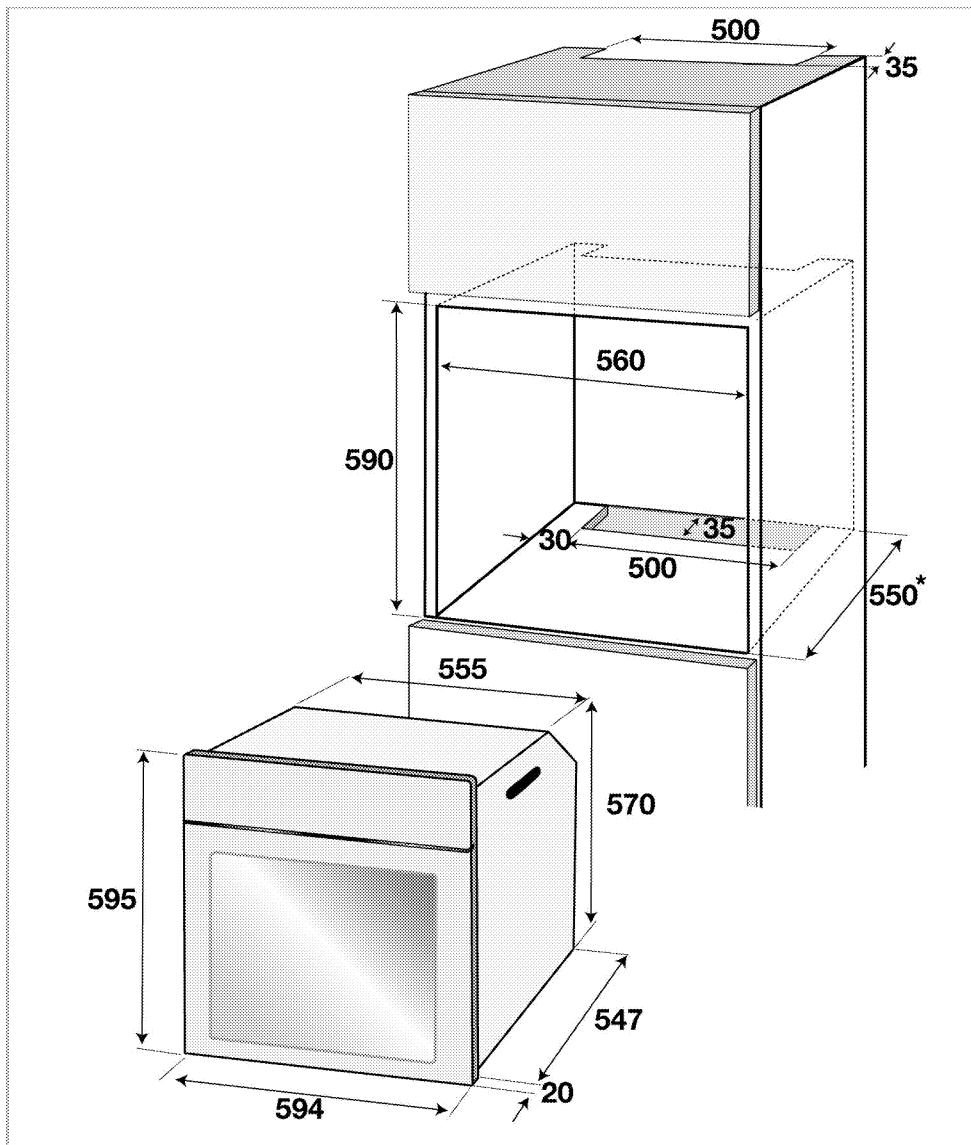

* min.

Appliance built-under of the hob and oven configuration

Description of hob	65 - 77 LT			80 - 82 LT	
	30 mm Counter	40 mm Counter	50 mm Counter	40 mm Counter	50 mm Counter
30 cm Induction Hob	√	√	√	√	√
60 cm Side Control Metal Gas Hob	√	√	√	√	√
30 cm Gas Hob (1 Wok)	√	√	√	-	√
30 cm Gas Hob (2 Gas)	-	√	√	-	√
90 cm Induction Hob with TFT Display	-	√	√	-	-
80 cm Induction Hob	-	√	√	-	√
80 cm Vitroceramic Hob with Touch slider control	√	√	√	-	√
70 cm Metal Gas Hob	√	√	√	-	√
70 cm Front Control Gas on Glass Hob	√	√	√	-	√
3 Wok Hob Burner Configuration	√	√	√	√	√
60 cm Front Control Gas on Glass Hob	√	√	√	-	√
60 cm Front Control Metal Gas Hob	√	√	√	-	√
60 cm Front Control Flat Metal Gas Hob	√	√	√	-	√
70 cm Front Control Flat Metal Gas Hob	√	√	√	-	√
30 cm Vitroceramic Hob	√	√	√	√	√
60 cm Induction Hob with Touch slider control	-	√	√	-	√
60 cm Induction Hob with 8 induction zones	-	√	√	-	-
60 cm Induction Hob with Basic Touch control	-	√	√	-	√
80 cm Induction Hob with Touch slider control	-	√	√	-	√
60 cm Vitroceramic Hob with Touch slider control	√	√	√	-	√
60 cm Vitroceramic Hob with Basic Touch control	√	√	√	√	√
80 cm Vitroceramic Hob with Touch slider control	√	√	√	-	√

Installation and connection

- The product must be installed in accordance with all local gas and electrical regulations.

Electrical connection

Connect the product to a grounded outlet/line protected by a miniature circuit breaker of suitable capacity as stated in the "Technical specifications" table. Have the grounding installation made by a qualified electrician while using the product with or without a transformer. Our company shall not be liable for any damages that will arise due to using the product without a grounding installation in accordance with the local regulations.

 **DANGER:** The product must be connected to the mains supply only by an authorised and qualified person. Manufacturer shall not be held responsible for damages arising from procedures carried out by unauthorised persons.

 **DANGER:** The power cable must not be clamped, bent or trapped or come into contact with hot parts of the product. A damaged power cable must be replaced by a qualified electrician. Otherwise, there is risk of electric shock, short circuit or fire!

- Connection must comply with national regulations.
- The mains supply data must correspond to the data specified

on the type label of the product. Open the front door to see the type label.

- Power cable of your product must comply with the values in "Technical specifications" table.

 **DANGER:** Before starting any work on the electrical installation, disconnect the product from the mains supply. There is the risk of electric shock!

Connecting the power cable

1. If a power cable is not supplied together with your product, a power cable that you would select from the table in accordance with the electrical installation at your home must be connected to your product by following the instructions in cable diagram.

This product must only be connected by a qualified electrician such as a technician from the local electricity company or NICEIC registered contractor to a suitable double-pole control unit with a minimum contact clearance of 3 mm in all poles. This control unit must be installed accordance with the IEE regulation. Failure to obey this instruction may cause operational problems and invalidate the product warranty.

 Additional protection by a residual current circuit breaker is recommended.

2. Open the terminal block cover with a screwdriver.

3. Insert the power cable through the cable clamp below the terminal and secure it to the main body with the integrated screw on cable clamping component.
4. Connect the cables according to the supplied diagram.

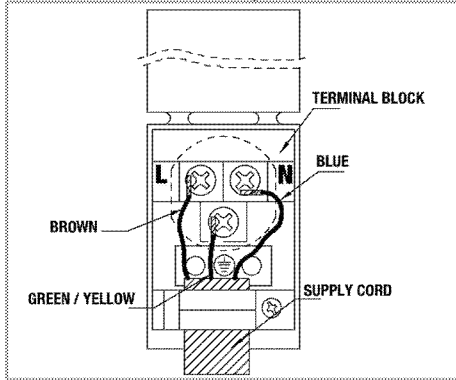

5. After completing the wire connections, close the terminal block cover.
6. Route the power cable so that it will not contact the product and get squeezed between the product and the wall.



Power cable must not be longer than 2 m because of safety reasons.

Installing the product

1. Slide the oven into the cabinet, align and secure it while making sure that the power cable is not broken and/or trapped.

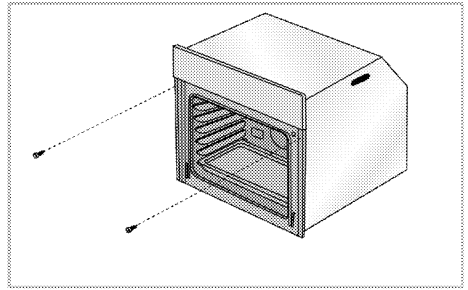

Secure the oven with 2 screws as illustrated.

For products with cooling fan (It may not exist on your product.)

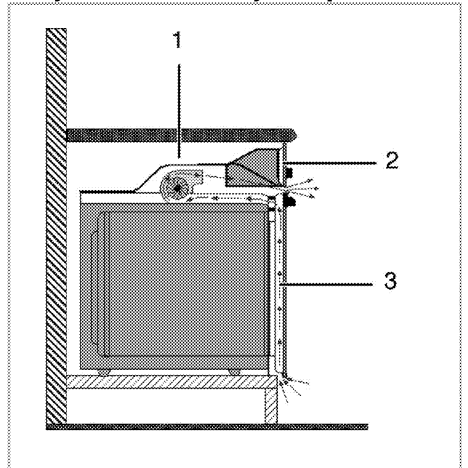

- 1 Cooling fan
- 2 Control panel
- 3 Door

The built-in cooling fan cools both the built-in cabinet and the front of the product.



Cooling fan continues to operate for about 20-30 minutes after the oven is switched off.

If you have cooked by programming the timer of the oven, cooling fan will also be switched off at the end of the cooking time together with all functions.

Final check

1. Operate the product.
2. Check the functions.

Future Transportation

- Keep the product's original carton and transport the product in it. Follow the instructions on the carton. If you do not have the original carton, pack the product in bubble wrap

or thick cardboard and tape it securely.

- To prevent the wire grill and tray inside the oven from damaging the oven door, place a strip of cardboard onto the inside of the oven door that lines up with the position of the trays. Tape the oven door to the side walls.
- Do not use the door or handle to lift or move the product.



Do not place any objects onto the product and move it in upright position.



Check the general appearance of your product for any damages that might have occurred during transportation.

4 Preparation

Tips for saving energy

The following information will help you to use your appliance in an ecological way, and to save energy:

- Use dark coloured or enamel coated cookware in the oven since the heat transmission will be better.
- While cooking your dishes, perform a preheating operation if it is advised in the user manual or cooking instructions.
- Do not open the door of the oven frequently during cooking.
- If door is not opened, inner temperature is optimized to save energy on ECO FAN HEATING mode and may differ from the display.

- Try to cook more than one dish in the oven at the same time whenever possible. You can cook by placing two cooking vessels onto the wire shelf.
- Cook more than one dish one after another. The oven will already be hot.
- You can save energy by switching off your oven a few minutes before the end of the cooking time. Do not open the oven door.
- Defrost frozen dishes before cooking them.

Initial use

Day time



Before you can use the oven, the time must be set. If the time is not set, oven will not operate.

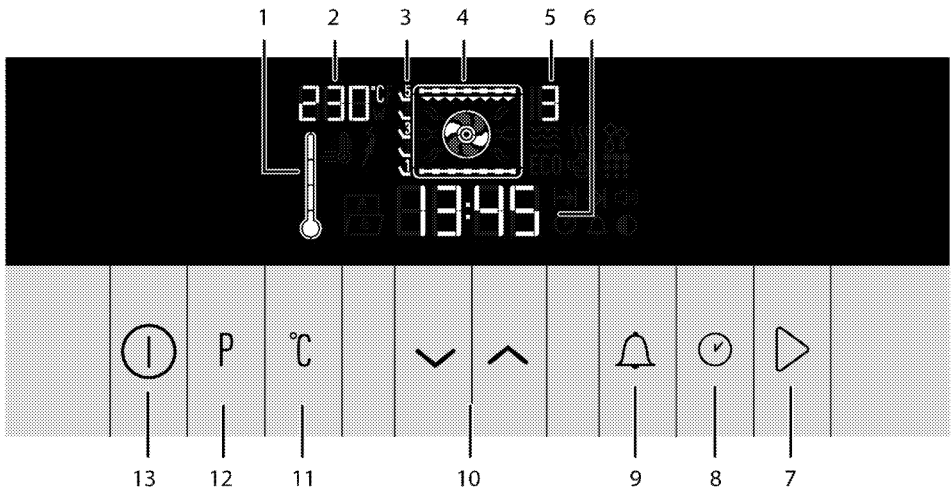





- | | | | |
|---|-------------------------------|---|------------------------------|
| 1 | Oven Inner Temperature symbol | 4 | Function display |
| 2 | Temperature indicator field | 5 | Function number |
| 3 | Shelf positions | 6 | Current time indicator field |

- 7 Start/stop cooking key
- 8 Time and settings key
- 9 Alarm key
- 10 Up/down keys (Menu step)
- 11 Temperature/booster setting key
- 12 Return Key to function display
- 13 ON/OFF key

Set the time



1. Switch on the power to the product.
2. "00:00" appears and  symbol flash on the display. Set the hour with / keys.

By pressing the  or  key you can take the time forward faster.

3. Touch  to confirm the setting.
 - » It returns to the stand-by display.
 Only the current time appears on the display.

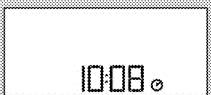

In case of power outage or when the product is disconnected from the mains supply and reconnected again, the time setting menu is displayed again. The set day time is preserved in short power outages. In such cases, you can continue by confirming the time value.

First cleaning of the appliance



The surface might get damaged by some detergents or cleaning materials.

Do not use aggressive detergents, cleaning powders/creams or any sharp objects during cleaning. Do not use harsh abrasive cleaners or sharp metal scrapers to clean the oven door glass since they can scratch the surface, which may result in shattering of the glass.

1. Remove all packaging materials.
2. Wipe the surfaces of the appliance with a damp cloth or sponge and dry with a cloth.

Initial heating

Heat up the product for about 30 minutes and then switch it off. Thus, any production residues or layers will be burnt off and removed.



WARNING

Hot surfaces cause burns! Product may be hot when it is in use. Never touch the hot burners, inner sections of the oven, heaters and etc. Keep children away. Always use heat resistant oven gloves when putting in or removing dishes into/from the hot oven.

Electric oven

1. Take all baking trays and the wire grill out of the oven.
2. Close the oven door.
3. Select Static position.

4. Select the highest grill power; See .
5. Operate the oven for about 30 minutes.
6. Turn off your oven; See

Grill oven

1. Take all baking trays and the wire grill out of the oven.
2. Close the oven door.
3. Select the highest grill power; see *How to operate the grill, page 37*.

4. Operate the grill about 30 minutes.
5. Turn off your grill; see *How to operate the grill, page 37*



Smoke and smell may emit for a couple of hours during the initial operation. This is quite normal. Ensure that the room is well ventilated to remove the smoke and smell. Avoid directly inhaling the smoke and the smell that emits.

5 How to operate the oven

General information on baking, roasting and grilling



WARNING

Hot surfaces cause burns!
Product may be hot when it is in use. Never touch the hot burners, inner sections of the oven, heaters and etc. Keep children away.
Always use heat resistant oven gloves when putting in or removing dishes into/from the hot oven.



DANGER:

Be careful when opening the oven door as steam may escape.
Exiting steam can scald your hands, face and/or eyes.

Tips for baking

- Use non-sticky coated appropriate metal plates or aluminum vessels or heat-resistant silicone moulds.
- Make best use of the space on the rack.
- Place the baking mould in the middle of the shelf.
- Select the correct rack position before turning the oven or grill on. Do not change the rack position when the oven is hot.
- Keep the oven door closed.

Tips for roasting

- Treating whole chicken, turkey and large piece of meat with dressings such as lemon juice and black pepper before

cooking will increase the cooking performance.

- It takes about 15 to 30 minutes longer to roast meat with bones when compared to roasting the same size of meat without bones.
- Each centimeter of meat thickness requires approximately 4 to 5 minutes of cooking time.
- Let meat rest in the oven for about 10 minutes after the cooking time is over. The juice is better distributed all over the roast and does not run out when the meat is cut.
- Fish should be placed on the middle or lower rack in a heat-resistant plate.

Tips for grilling

When meat, fish and poultry are grilled, they quickly get brown, have a nice crust and do not get dry. Flat pieces, meat skewers and sausages are particularly suited for grilling as are vegetables with high water content such as tomatoes and onions.

- Distribute the pieces to be grilled on the wire shelf or in the baking tray with wire shelf in such a way that the space covered does not exceed the size of the heater.
- Slide the wire shelf or baking tray with grill into the desired level in the oven. If you are

grilling on the wire shelf, slide the baking tray to the lower rack to collect fats. Add some water in the tray for easy cleaning.

How to operate the electric oven



Before you can use the oven, the time must be set. If the time is not set, oven will not operate.



Foods that are not suitable for grilling carry the risk of fire. Only grill food which is suitable for intensive grilling heat. Do not place the food too far in the back of the grill. This is the hottest area and fatty food may catch fire.

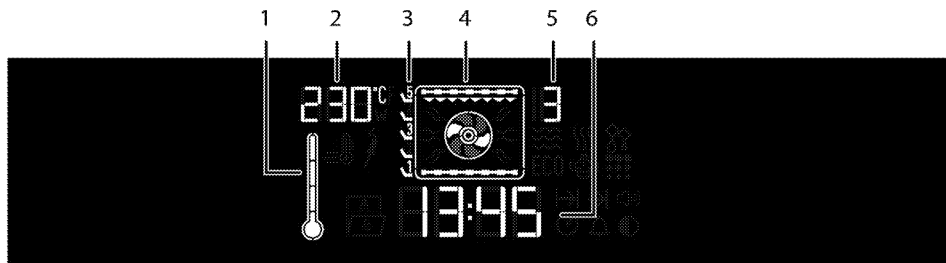

13



12



11



10



9



8



7

- 1 Oven Inner Temperature symbol
- 2 Temperature indicator field
- 3 Shelf positions
- 4 Function display
- 5 Function number
- 6 Current time indicator field
- 7 Start/stop cooking key
- 8 Time and settings key
- 9 Alarm key
- 10 Up/down keys (Menu step)
- 11 Temperature/booster setting key
- 12 Return Key to function display
- 13 ON/OFF key



Alarm symbol



Current time symbol



Volume setting symbol



Brightness setting symbol



Defrost symbol



Keylock symbol



Door open symbol



Oven inner temperature symbol

Meat probe symbol *

Pyro symbol *

Steam symbol *

* Varies depending on the product model.

Display symbols:





Rapid heating (Booster) symbol



Cooking time symbol







End of cooking time symbol



Oven returns to stand-by display after it is switched on and the current time is set. Only the current time appears on the display. Only the  and  keys are functional when the display is in this status. You can perform all actions in the Settings menu.

While the oven is hot, it is possible to see inner temperature of oven by touching key .

Select temperature and operating mode

1. Touch  key to switch on the oven.
2. Initial operation screen appears when the oven is turned on. This screen contains the recommended temperature in the temperature indicator, and the active heaters, function number and recommended tray position appear in the function display.





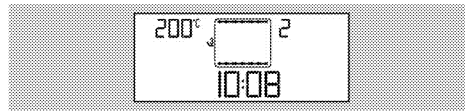

 If you touch  key briefly in this screen, the oven will give an audible warning. Touch the  key for longer than 1 second to switch on the oven.

3. Touch  or  keys to select the desired operating mode [function].

After the function is selected, "Temperature", "Cook time", "Cook end time" and "Booster" (rapid heating) can be set.

4. Touch the  key for once to change the temperature. "°C" symbol flashes



5. Touch  /  keys until the desired temperature appears in the Temperature indicator. Touch  ,  or  key once when the desired value appears on the display. If you do not touch any key, the set value will be automatically confirmed after 10 seconds.
6. If cooking function and temperature values are suitable, touch  key to start cooking.

Cooking starts and  appears on the display. As the inner temperature increases, the level in the middle of the symbol also increases.

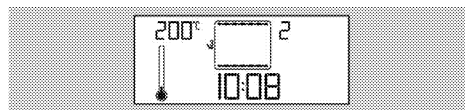

 If the oven door is opened during cooking,  symbol appears on the display.

Switching off the electric oven

Touch  key to switch off the oven. It is important to place the wire grill onto the wire rack correctly. Wire grill must be inserted between the wire racks as illustrated in the figure.

Do not let the wire grill stand against the rear wall of the oven. Slide your wire grill to the front section of the rack and settle it with

the help of the door in order to obtain a good grill performance.

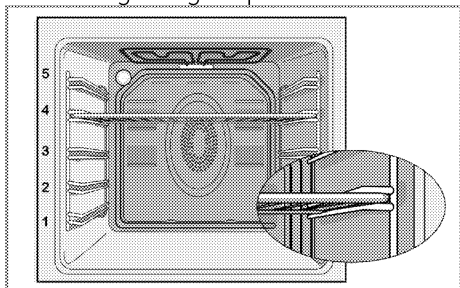

Rack positions (For models with wire grill)

It is important to place the wire grill onto the wire rack correctly. Wire grill must be inserted between the wire racks as illustrated in the figure.

Do not let the wire grill stand against the rear wall of the oven. Slide your wire grill to the front section of the rack and settle it with the help of the door in order to obtain a good grill performance.

Function table

Function table indicates the functions that can be used in the oven and their respective maximum and minimum temperatures.

- i** Functions vary depending on the product model.
- i** Maximum adjustable cooking time in modes except "warm keeping" function is limited with 6 hours due to safety reasons.
- i** While making any adjustment, related symbols will flash on the display.

- i** You can return to the function display by touching **P** key in any screen.
- i** Program will be cancelled in case of power failure. You must reprogram the oven.
- i** Current time cannot be set while the oven is operating in any function, or if semi-automatic or full automatic programming is made on the oven.
- i** Even if the oven is switched off, oven lamp lights up when the oven door is opened.

Function	Recommended temperature (°C)	Temperature range (°C)
Static	200	40-280
Static + fan	175	40-280
Fan heating	180	40-280
Multi (3D)	205	40-280
Fan heat.+bottom	210	40-280
Full grill+Fan	200	40-280
Full grill	280	40-280
Low grill	280	40-280
Eco fan	180	160-220
Bottom heating	180	40-220
Warm keeping	60	40-100
Defrost	-	-
* Functions vary depending on the product model.		

Operating modes

The order of operating modes shown here may be different from the arrangement on your product.

1. Top and bottom heating

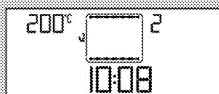

Food is heated simultaneously from the top and bottom. For example, it is suitable for cakes, pastries, or cakes and casseroles in baking moulds. Cook with one tray only. Suitable rack position will be displayed on screen.

2. Fan supported bottom/top heating

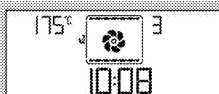

Hot air heated by the bottom and top heaters is evenly distributed throughout the oven rapidly by means of the fan. Cook with one tray.

3. Fan Heating

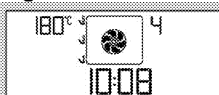

Warm air heated by the rear heater is evenly distributed throughout the oven rapidly by means of the fan. It is suitable for cooking your meals in different rack levels and preheating is not required in most cases. Suitable for cooking with multi trays.

 When the oven door is opened, the fan motor will not run in order to keep the hot air inside.

4. "3D" function



Top heating, bottom heating and fan assisted heating are in operation. Food is cooked evenly and quickly all around. Cook with one tray only.

5. Pizza function



The bottom heating and fan assisted heating are in operation. Suitable for baking pizza.

6. Full grill+Fan



Hot air heated by the full grill is distributed very fast in the oven by means of the fan. It is suitable for grilling large amount of meat.

- Put big or medium-sized portions in correct rack position under the grill heater for grilling.
- Set the temperature to maximum level.
- Turn the food after half of the grilling time.

7. Full grill



Large grill at the ceiling of the oven is in operation. It is

suitable for grilling large amount of meat.

- Put big or medium-sized portions in correct rack position under the grill heater for grilling.
- Set the temperature to maximum level.
- Turn the food after half of the grilling time.

8. Grill

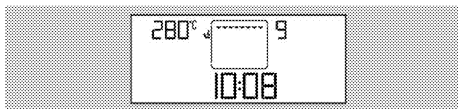

Small grill at the ceiling of the oven is in operation. Suitable for grilling and gratin dishes.

- Put small or medium-sized portions in correct shelf position under the grill heater for grilling.
- Set the temperature to maximum level.
- Turn the food after half of the grilling time.

9. Eco Fan Heating

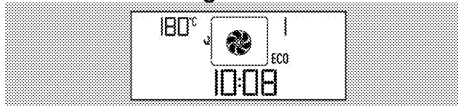

To save power, you can use this function instead of the cooking operations that you would perform by using Fan Heating at 160-220°C temperature range. But, the cooking time will increase a little bit.

Cooking times related to this function are indicated in '**Eco Fan Heating**' table.

10. Bottom heating



Only bottom heating is in operation. It is suitable for pizza and for subsequent browning of food from the bottom.

11. Keep warm



Used for keeping food at a temperature ready for serving for a long period of time.

12. Operating with fan



The oven is not heated. Only the fan (in the rear wall) is in operation. Suitable for thawing frozen granular food slowly at room temperature and cooling down the cooked food.

13. Easy steam cleaning

(This feature is optional. It may not exist on your product.)



This function enables the dirt (having waited not for too long) in the oven to get soft and be cleaned easily. Please see "Cleaning - easy steam cleaning" section for easy steam cleaning.

How to operate the oven control unit

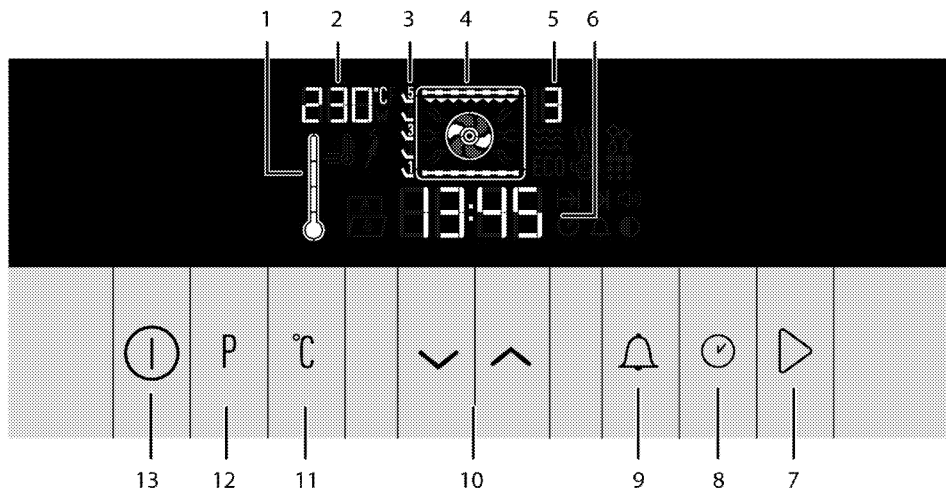







- 1 Oven Inner Temperature symbol
- 2 Temperature indicator field
- 3 Shelf positions
- 4 Function display
- 5 Function number
- 6 Current time indicator field
- 7 Start/stop cooking key
- 8 Time and settings key
- 9 Alarm key
- 10 Up/down keys (Menu step)
- 11 Temperature/booster setting key
- 12 Return Key to function display
- 13 ON/OFF key

Enable semi-automatic operation





In this operation mode, you may adjust the time period during which the oven will operate (cook time).

1. Touch  key to switch on the oven.

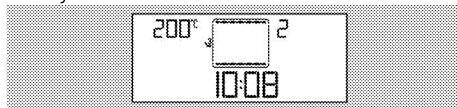



 If you touch  key briefly in this screen, the oven will give an audible warning. Touch the  key for longer than 1 second to switch on the oven.

2. Touch  or  keys to select the desired operating mode (function).
3. Touch the  key for once to change the temperature. "°C" symbol flashes





4. Touch / until the desired temperature appears in the Temperature/Weight Indicator field. Touch ,  or  key once when the desired value appears on the display. If you do not touch any key, the set value will

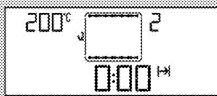

be automatically confirmed after 10 seconds.

- For cooking time, press  key for once to scroll to the "Cook time" on the text display.  symbol flashes at the same time.
- Touch  keys to set the desired cooking time and confirm the setting by touching the  key. Once the Cook Time is set,  will be displayed continuously.







- Put your dish into the oven and close the door.
- If cooking function, temperature and time values are suitable, touch  key to start cooking.

Cooking starts and  appears on the display.

 If you touch  key briefly in this screen, the oven will give an audible warning.
Touch the  key for longer than 1 second to start cooking.





» The oven will be heated up to the preset temperature and will maintain this temperature until the end of the cooking time you selected. The oven lamp is lit during the cooking process.

 All segments of the  symbol will light up when the oven reaches the set temperature.





- After the cooking is completed, the oven will give an audible warning.
- To stop the audible warning, just touch any key. If  is touched, the oven will continue operating in the selected mode. Audible warning stops.
- Oven is switched off automatically and the current time is displayed if you do not touch the  key.

Switch on fully automatic operation

In this operation mode you can adjust cooking time and end of cooking time.

- Touch  key to switch on the oven.
- Touch  or  keys to select the desired operating mode [function].
- If you want to change the temperature, touch  once to reach the temperature display.



- Touch  until the desired temperature appears in the Temperature/Weight Indicator field. Touch ,  or  key once when the desired value appears on the display. If you do not touch any key, the set value will be automatically confirmed after 10 seconds.
- For cooking time, press  key for once to scroll to the "Cook

time" on the text display. \rightarrow symbol flashes at the same time.

6. Touch \wedge/\vee keys to set the desired cooking time and confirm the setting by touching the \odot key. Once the Cook Time is set, \rightarrow will be displayed continuously.

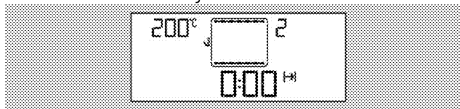

7. Touch the \odot key twice for the End of Cooking Time. Meanwhile, \rightarrow flashes in the display.

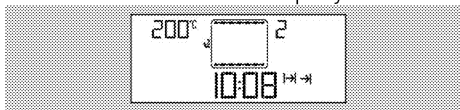

8. Touch \wedge/\vee keys to set the desired end of cooking time and confirm the setting by touching the \odot key. Once the Cook end time is set, \rightarrow will be displayed continuously.
9. Put your dish into the oven and close the door.
10. If cooking function, temperature, time and end of cooking time values are suitable, touch \triangleright key to start cooking.

» Oven timer automatically calculates the startup time for cooking by deducting the cooking time from the end of cooking time you have set.

11. Selected operation mode is activated when the startup time of cooking has come. Cooking starts and \downarrow appears on the display. Oven heats up to the

adjusted temperature. It maintains this temperature until the end of the cooking time. The oven lamp is lit during the cooking process.

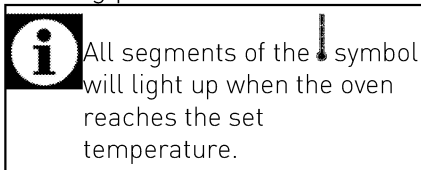

12. After the cooking is completed, the oven will give an audible warning.
13. To stop the audible warning, just touch any key. If \triangleright is touched, the oven will continue operating in the selected mode. Audible warning stops.

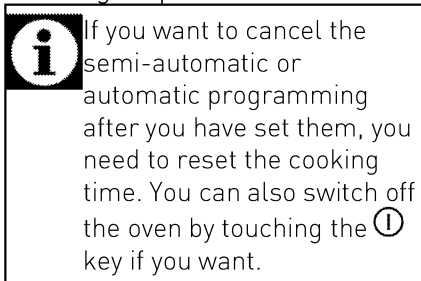

Setting the booster (Quick heating)

Use Booster (rapid pre-heating) function to make the oven reach the desired temperature faster.

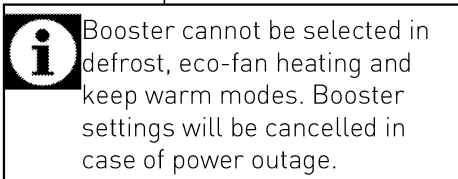

Select the desired cooking function and then:

1. Touch the C key twice. "OFF" will appear on the display.

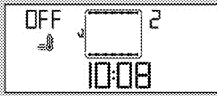

2. Touch the key for once. "ON" and symbol appear on the display. Touch the key to confirm the setting.

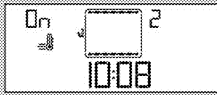

3. If cooking function and temperature values are suitable, touch key to start cooking.

Cooking starts and appears on the display.

» symbol disappears as soon as the oven reaches the desired temperature and oven resumes operating in the function it was in before the Booster function.

4. To cancel Booster function, touch the key with short intervals until "ON" appears on the display.
5. Touch the key for once. "OFF" will appear and symbol disappears on the display. Touch the key to confirm setting.



Using the keylock

You can prevent oven from being intervened with by activating the Keylock function.

Keylock can be used either when the oven is operating or not. Oven can be switched off by touching the key even when the keylock is activated while the oven is operating.

Activating the keylock

1. Touch the key with short intervals until symbol appears on the display. "OFF" appears and the symbol flashes on the display.
2. Touch key for once to activate the keylock. "ON" will be displayed once the keylock is set. Then, the symbol will appear.
3. Touch to confirm the setting.



» After activating the keylock, "Keylock active" warning and symbol will appear on the display when you press any key (except / keys).

Oven keys are not functional when the Keylock function is activated. Keylock will not be cancelled in case of power outage.

Deactivating the keylock



1. Touch key twice to deactivate the keylock.
- » Key lock is deactivated and the symbol on the display disappears.

Using the clock as an alarm

You can use the clock of the product for any warning or reminder apart from the cooking programme.

The alarm clock has no influence on the functions of the oven. It is only used as a warning. For example, this is useful when you want to turn food in the oven at a certain point of time. Alarm clock will give a signal once the time you set is over.



Maximum alarm time can be 23 hours and 59 minutes.

To set the alarm:

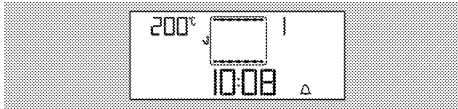

1. Touch the key. symbol flashes on the display.

Cooking times table



The timings in this chart are meant as a guide. Timings may vary due to temperature of food, thickness, type and your own preference of cooking.

2. Touch / keys to set the desired time and confirm the setting by touching the key. symbol remains lit after setting the alarm time.
3. After the alarm time is finished, will start flashing and an alarm signal is heard.
4. Press any key to stop the alarm.

To cancel the alarm:























1. Touch the key. symbol flashes on the display.
 2. Touch the key until "00:00" appears on the display and confirm the setting by touching the key.
- » Alarm is cancelled and symbol disappears.

Baking and roasting



1st rack of the oven is the bottom rack.

Dish	Cooking level number		Rack position	Temperature (°C)	Cooking time (approx. in min.)
Cakes in tray*	One level		3	175	25 ... 30
Cakes in mould*	One level		2	180	40 ... 50
Cakes in cooking paper*	One level		3	175	25 ... 30
	2 levels		1 - 5	175	30 ... 40
	3 levels		1 - 3 - 5	180	45 ... 55
Sponge cake*	One level		3	200	5 ... 10
	2 levels		1 - 5	175	20 ... 30
Cookies*	One level		3	175	25 ... 30

	2 levels		1 - 5	170 ... 190	30 ... 40
	3 levels		1 - 3 - 5	175	35 ... 45
Dough pastry*	One level		2	200	30 ... 40
	2 levels		1 - 5	200	45 ... 55
	3 levels		1 - 3 - 5	200	55 ... 65
Rich pastry*	One level		2	200	25 ... 35
	2 levels		1 - 5	200	35 ... 45
	3 levels		1 - 3 - 5	190	45 ... 55
Leaven*	One level		2	200	35 ... 45
	2 levels		1 - 3	190	35 ... 45
Lasagna*	One level		2 - 3	200	30 ... 40
Pizza*	One level		2	200 ... 220	15 ... 20
	One level		3	200	10 ... 15
Beef steak (whole) / Roast	One level		3	25 min. 250/max, then 180 ... 190	100 ... 120
Leg of Lamb (casserole)	One level		3	25 min. 250/max, then 190	70 ... 90
	One level		3	25 min. 250/max, then 190	60 ... 80
Roasted chicken	One level		2	15 min. 250/max, then 180 ... 190	55 ... 65
	One level		2	15 min. 250/max, then 180 ... 190	55 ... 65
Turkey (5.5 kg)	One level		1	25 min. 250/max, then 180 ... 190	150 ... 210
	One level		1	25 min. 250/max, then 180 ... 190	150 ... 210
Fish	One level		3	200	20 ... 30
	One level		3	200	20 ... 30
When cooking with 2 trays at the same time, place the deeper tray on the upper rack and the other one on the lower rack.					
* It is suggested to perform preheating for all foods.					

Eco Fan Heating



Do not change the cooking temperature after cooking starts in Eco Fan Heating mode.



Do not open the door during cooking in the Eco Fan Heating mode. If door is not opened, inner temperature is optimized to save energy and may differ from the display.

Dish	Cooking level number	Rack position	Temperature (°C)	Cooking time (approx. in min.)
Cakes in cooking paper	One level	3	200	35 ... 40
Cookies	One level	3	200	30 ... 35
Dough pastry	One level	3	200	40 ... 45
Rich pastry	One level	3	200	40 ... 45

Tips for baking cake

- If the cake is too dry, increase the temperature by 10°C and decrease the cooking time.
- If the cake is wet, use less liquid or lower the temperature by 10°C.
- If the cake is too dark on top, place it on a lower rack, lower the temperature and increase the cooking time.
- If cooked well on the inside but sticky on the outside use less liquid, lower the temperature and increase the cooking time.

Tips for baking pastry

- If the pastry is too dry, increase the temperature by 10°C and decrease the cooking time. Dampen the layers of dough with a sauce composed of milk, oil, egg and yoghurt.
- If the pastry takes too long to bake, pay care that the thickness of the pastry you have prepared does not exceed the depth of the tray.

- If the upper side of the pastry gets browned, but the lower part is not cooked, make sure that the amount of sauce you have used for the pastry is not too much at the bottom of the pastry. Try to scatter the sauce equally between the dough layers and on the top of pastry for an even browning.



Cook the pastry in accordance with the mode and temperature given in the cooking table. If the bottom part is still not browned enough, place it on one lower rack next time.



Tips for cooking vegetables

- If the vegetable dish runs out of juice and gets too dry, cook it in a pan with a lid instead of a tray. Closed vessels will preserve the juice of the dish.
- If a vegetable dish does not get cooked, boil the vegetables beforehand or prepare them like canned food and put in the oven.



Settings menu

Brightness setting

Brightness can only be set when the oven is switched off.

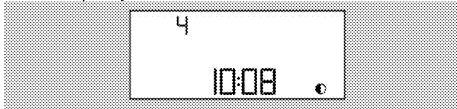
1. Touch  key with short intervals until  symbol appears on the display.  symbol flashes on the display.



2. There are 4 brightness levels, namely 1, 2, 3 and 4. Touch / keys to select the desired level.
3. Touch  to confirm the setting.





Brightness level decreases to save power when the oven is switched off. It restores to the set level again when the oven is switched on.



» It returns to the stand-by display. Only the current time appears on the display.

Voice Level setting

Voice level can only be set when the oven is switched off.

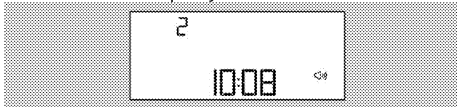
1. Touch the  key with short intervals until  symbol appears on the display.  symbol flashes on the display.







2. There are 2 voice levels, namely 1 and 2. Touch / keys to select the desired level.
3. Touch  to confirm the setting.

» It returns to the stand-by display. Only the current time appears on the display.

Current time setting

Current time can only be set when the oven is switched off. If you want to change the time that was set during initial setup:



1. Touch  key with short intervals until  symbol appears on the display. Hour field and  symbol flash on the display. Touch / keys to set the hour.

By pressing the  or  key you can take the time forward faster.

2. Touch  to confirm the hour.
» It returns to the stand-by display. Only the current time appears on the display.



How to operate the grill



Before you can use the oven, the time must be set. If the time is not set, oven will not operate.



WARNING

Close oven door during grilling. Hot surfaces may cause burns!

Switching on the grill

1. Touch key to switch on the oven.
2. Touch to select the desired grill function.

After the function is selected, "Temperature", "Cook time", "Cook end time" and "Booster" (rapid heating) can be set.

3. Touch the key for once to change the temperature. "°C" symbol flashes
4. Touch keys until the desired temperature appears in the Temperature indicator. Touch , or key once when the desired value appears on the

display. If you do not touch any key, the set value will be automatically confirmed after 10 seconds.

5. If cooking function and temperature values are suitable, touch key to start cooking.

Cooking starts and appears on the display. As the inner temperature increases, the level in the middle of the symbol also increases.

Switching off the grill

1. Touch key to switch off the oven.



Foods that are not suitable for grilling carry the risk of fire. Only grill food which is suitable for intensive grilling heat. Do not place the food too far in the back of the grill. This is the hottest area and fatty food may catch fire.

Cooking times table for grilling

Grilling with electric grill

Food	Insertion level	Grilling time (approx.)
Fish	4...5	20...25 min. #
Sliced chicken	4...5	25...35 min.
Lamb chops	4...5	20...25 min.
Roast beef	4...5	25...30 min. #
Veal chops	4...5	25...30 min. #
Toast bread	4	1...2 min.

depending on thickness

6 Maintenance and care

General information

Service life of the product will extend and the possibility of problems will decrease if the product is cleaned at regular intervals.



DANGER:

Disconnect the product from mains supply before starting maintenance and cleaning works.

There is the risk of electric shock!



DANGER:

Allow the product to cool down before you clean it.

Hot surfaces may cause burns!

- Clean the product thoroughly after each use. In this way it will be possible to remove cooking residues more easily, thus avoiding these from burning the next time the appliance is used.
- No special cleaning agents are required for cleaning the product. Use warm water with washing liquid, a soft cloth or sponge to clean the product and wipe it with a dry cloth.
- Always ensure any excess liquid is thoroughly wiped off after cleaning and any spillage is immediately wiped dry.
- Do not use cleaning agents that contain acid or chloride to clean the stainless or inox surfaces and the handle. Use a soft cloth with a liquid detergent (not abrasive) to wipe those parts

clean, paying attention to sweep in one direction.



The surface might get damaged by some detergents or cleaning materials.

Do not use aggressive detergents, cleaning powders/creams or any sharp objects during cleaning.
Do not use harsh abrasive cleaners or sharp metal scrapers to clean the oven door glass since they can scratch the surface, which may result in shattering of the glass.



Do not use steam cleaners to clean the appliance as this may cause an electric shock.

Cleaning the control panel

Clean the control panel and knobs with a damp cloth and wipe them dry.



Do not remove the control buttons/knobs to clean the control panel.

Control panel may get damaged!

Cleaning the oven

To clean the side wall

(This feature is optional. It may not exist on your product.)

1. Remove the front section of the side rack by pulling it in the opposite direction of the side wall.

2. Remove the side rack completely by pulling it towards you.

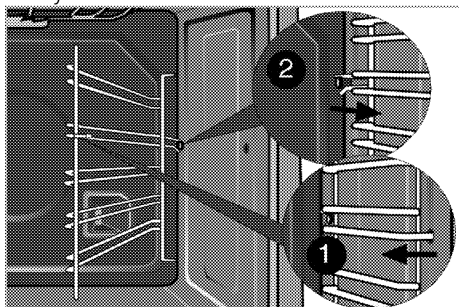

Catalytic walls

(This feature is optional. It may not exist on your product.)

The inner side walls (A) and/or the rear wall (B) of your product may be coated with catalytic enamel. Catalytic walls have a light matte colour and a porous surface. Catalytic walls of the oven should not be cleaned. Porous surfaces of the catalytic walls are automatically cleaned by absorbing and converting the spilled oil (steam and carbon dioxide).

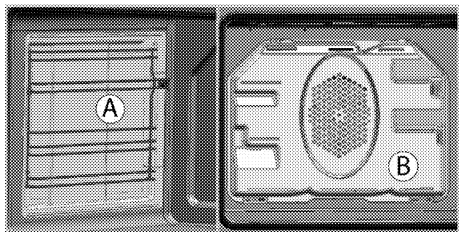

Easy Steam Cleaning

(This feature is optional. It may not exist on your product.)

It ensures easy cleaning because the dirt (having waited not for too long) is softened with the steam that forms inside the oven and the

water drops condensing on the inner surfaces of the oven.

1. Remove all accessories inside the oven.
2. Pour 500 ml of water into the oven tray and place the tray at the 2nd rack of the oven.

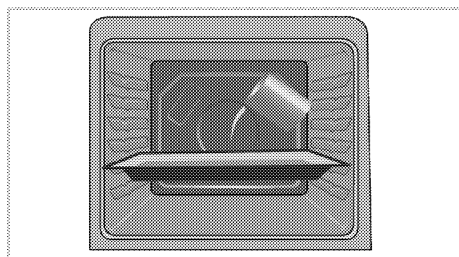

3. Select easy steam cleaning function. Cleaning duration will appear on the screen and it cannot be changed. You can set the end time for this cleaning function.
4. Open the door and wipe the inner surfaces of the oven with a damp sponge or cloth.
5. Use warm water with washing liquid, a soft cloth or sponge to clean the persistent dirt and wipe it with a dry cloth.

Clean oven ceiling

The grill element can be folded down to enable cleaning of the oven cavity ceiling.

1. Loosen the locking screws at the front of the grill element with a screwdriver or coin.

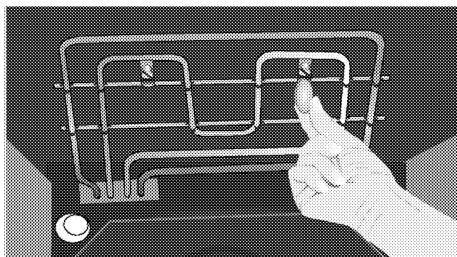

i The grill element folds down. It remains anchored at the oven ceiling.

2. Clean oven ceiling with a damp cloth.

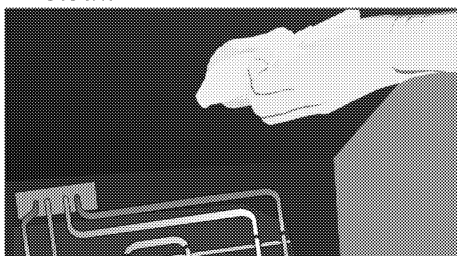

3. Fold the grill element up again and tighten the locking screws with a screwdriver or a coin.

Clean oven door

To clean the oven door, use warm water with washing liquid, a soft cloth or sponge to clean the product and wipe it with a dry cloth.

i Don't use any harsh abrasive cleaners or sharp metal scrapers for cleaning the oven door. They could scratch the surface and destroy the glass.

i Front door inner glass is coated to easy clean material. Do not use any harsh abrasive cleaners, hard metal scrapers, scouring pads or bleach to clean front door inner glass as they may scratch the surface. This may destroy the coating material.

Removing the oven door

1. Open the front door (1).
2. Open the clips at the hinge housing (2) on the right and left hand sides of the front door by pressing them down as illustrated in the figure.

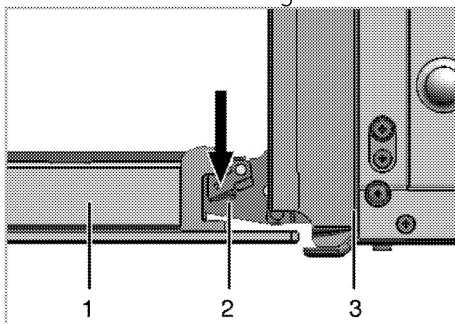

- 1 Front door
- 2 Hinge
- 3 Oven

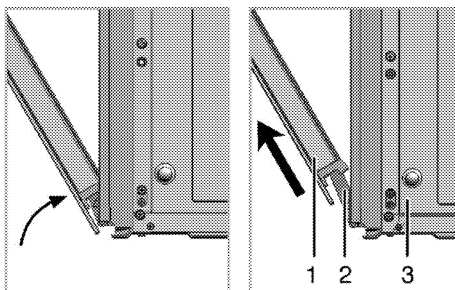

3. Move the front door to half-way.

4. Remove the front door by pulling it upwards to release it from the right and left hinges.



Steps carried out during removing process should be performed in reverse order to install the door. Do not forget to close the clips at the hinge housing when reinstalling the door.

Removing the door inner glass (This feature is optional. It may not exist on your product.)

The inner glass panel of the oven door can be removed for cleaning. Open the oven door.

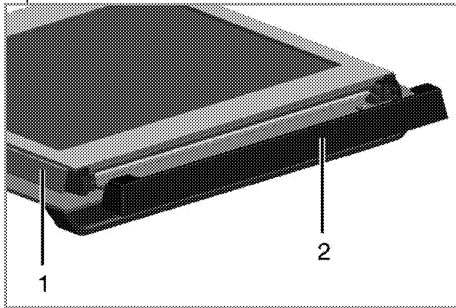

- 1 Frame
2 Plastic part

Pull towards yourself and remove the plastic part installed to upper section of the front door.

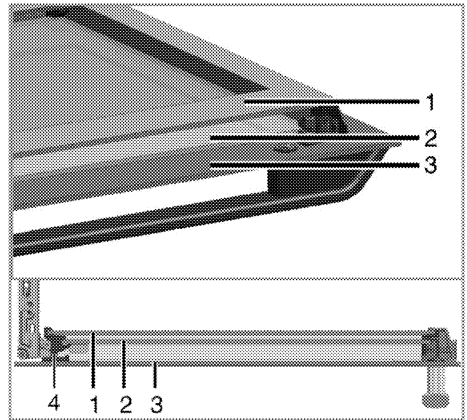

- 1 Innermost glass panel
2 Inner glass panel
3 Outer glass panel
4 Plastic glass panel slot-Lower

As illustrated in figure, raise the innermost glass panel (1) slightly in direction **A** and pull it out in direction **B**.

Repeat the same procedure to remove the inner glass panel (2).

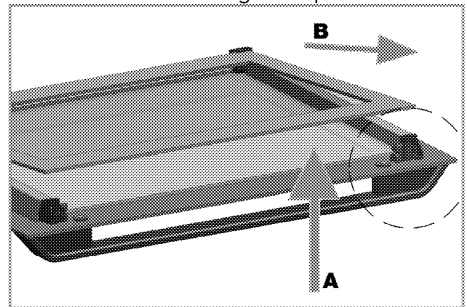

The first step to regroup the door is reinstalling inner glass panel (2). As illustrated in figure, place the chamfered corner of the glass panel so that it will rest in the chamfered corner of the plastic slot.

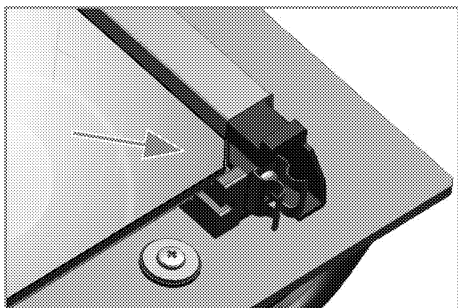

Inner glass panel (2) must be installed into the plastic slot close the innermost glass panel (1). When installing the innermost glass panel (1), make sure that the printed side of the panel faces towards the inner glass panel. It is important to seat lower corner of inner glass panel into the lower plastic slot. Push the plastic part towards the frame until you hear a "click".

Replacing the oven lamp



DANGER:

Before replacing the oven lamp, make sure that the product is disconnected from mains and cooled down in order to avoid the risk of an electrical shock. Hot surfaces may cause burns!



The oven lamp is a special electric light bulb that can resist up to 300 °C. See *Technical specifications, page 12* for details. Oven lamps can be obtained from Authorised Service Agents or technician with licence.



Position of lamp might vary from the figure.



The lamp used in this appliance is not suitable for household room illumination. The intended purpose of this lamp is to assist the user to see foodstuffs.



The lamps used in this appliance have to withstand extreme physical conditions such as temperatures above 50 °C.

If your oven is equipped with a round lamp:

1. Disconnect the product from mains.
2. Turn the glass cover counter clockwise to remove it.

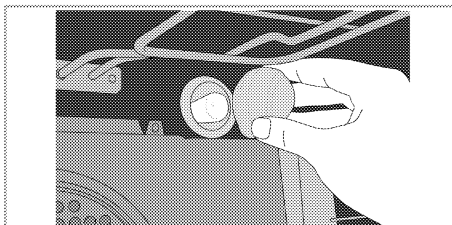

3. If your oven lamp is of type (A) shown in the figure below, remove it by rotating as shown and replace it. If it is of type (B), pull and remove it as shown in the figure and replace it.

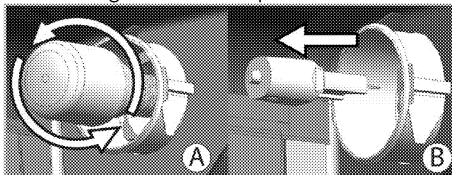

4. Install the glass cover.

7 Troubleshooting

Oven emits steam when it is in use.

- It is normal that steam escapes during operation. →→→ *This is not a fault.*

Product emits metal noises while heating and cooling.

- When the metal parts are heated, they may expand and cause noise. →→→ *This is not a fault.*

Product does not operate.

- The mains fuse is defective or has tripped. →→→ *Check fuses in the fuse box. If necessary, replace or reset them.*
- Product is not plugged into the (grounded) socket. →→→ *Check the plug connection.*
- Buttons/knobs/keys on the control panel do not function. →→→ *Keylock may be enabled. Please disable it. (See.)*

Oven light does not work.

- Oven lamp is defective. →→→ *Replace oven lamp.*
- Power is cut. →→→ *Check if there is power. Check the fuses in the fuse box. If necessary, replace or reset the fuses.*

Oven does not heat.

- Function and/or Temperature are not set. →→→ *Set the function and the temperature with the Function and/or Temperature knob/key.*
- Power is cut. →→→ *Check if there is power. Check the fuses in the fuse box. If necessary, replace or reset the fuses.*



Consult the Authorised Service Agent or technician with licence or the dealer where you have purchased the product if you can not remedy the trouble although you have implemented the instructions in this section. Never attempt to repair a defective product yourself.

8 Guarantee Details

Your new Grundig product is guaranteed against faulty materials, defective components or manufacturing defects. The guarantee starts from the date of original purchase of the product for a period of three (3) years unless Beko plc (the "Manufacturer") agrees to extend the guarantee for the product in writing. If you have any questions about the guarantee on your product (including how long it is valid), please contact your retailer or our Call Centre on 0333 207 9920.

This guarantee does not in any way diminish or affect your statutory rights in connection with the product. This guarantee is in addition to your statutory rights as a consumer. If you have any question about these rights, please contact the retailer from which you purchased the product. In certain circumstances, it is possible that your statutory rights may offer additional or higher levels of protection than those offered under the terms of this guarantee.

What is covered by this guarantee?

- Repairs to the product required as a result of faulty materials, defective components or manufacturing defects.
- Functional replacement parts to repair a product.
- The costs of a Grundig Approved Engineer to carry out the repair.

What is not covered?

- Transit and delivery damage.
- Cabinet or appearance parts, including but not limited to control knobs, flaps and handles.
- Accessories and/or consumable items including but not limited to ice trays, scrapers, cutlery baskets, filters and light bulbs.
- Repairs necessary as a direct or indirect result of:
 - Accidental damage, misuse or abuse of a product.
 - An attempted repair of a product by anyone other than a Grundig Approved Engineer (the "Engineer").
 - Installation or use of a product where such installation or use fails to meet the requirements contained in this guarantee or the User Instructions Booklet.
- Repairs to a product operated at any time on commercial or non-residential household premises (unless we have previously agreed to the installation environment).

This guarantee is limited to the cost of repairing the product. To the extent permitted by law, Beko plc (the "Manufacturer") does not accept and will not be held liable for any financial loss incurred in connection with the failure of any product to operate in accordance with the expected standards. Such financial loss includes but is not limited to loss arising from:

- Time taken off work.
- Damaged food, clothing or other items.
- Meals taken at restaurants or from takeaways.
- General compensation for inconvenience.

Important Notes

- Your product is designed and built for domestic household use only.
- The guarantee will automatically be void if the product is installed or is used in commercial or non-residential domestic household premises, unless we have previously agreed to the installation environment.
- The product must be correctly installed, located and operated in accordance with the instructions contained in the User Instructions Booklet provided with your product.
- Professional installation by a qualified Electrical Domestic Appliance Installer is recommended for all Washing Machines, Dishwashers and Electric Cookers (as incorrect installation may result in you having to pay for the cost of repairing the product).
- Gas Cookers must be professionally installed by a Gas Safe (or Gas Networks Ireland for Republic of Ireland) registered gas installer.
- This guarantee is given in respect of products purchased and used within the United Kingdom and the Republic of Ireland.
- This guarantee is effective from the initial date of purchase of a new product from an authorised retailer and will be void if the product is resold.
- This guarantee does not apply to graded sales (where the product is purchased as a "second").
- Possession of a copy of these terms and conditions does not necessarily mean that a product has the benefit of this guarantee. If you have any questions, please call our Call Centre on the number set out above.
- The Manufacturer reserves the right to terminate the guarantee if its staff or representatives are subjected to physical or verbal abuse in the course of carrying out their duties.
- Optional extras, where available (i.e. extendable feet) are supplied on a chargeable basis only.

Does Grundig offer replacements?

This is a repair-only guarantee. On occasion, the Manufacturer may at its sole discretion, replace your product with a new product instead of carrying out a repair. Where a replacement is offered, this would normally be an identical model, but when this is not possible, a model of similar specification will be provided. The Manufacturer will cover the costs and arrange for the delivery of the new product and for the return of the old product. Any costs related to disconnecting the faulty product and installing the replacement product will not be borne by the Manufacturer unless previously agreed to in writing. The original guarantee will continue to apply to the replacement product; the new product will not come with a new guarantee.

When will the repair take place?

Our Engineers work Monday to Friday 9.00am to 5.00pm. Appointments outside these hours may be possible at the sole discretion of the Manufacturer but cannot be guaranteed. Whilst our Engineers will endeavour to minimize inconvenience and to meet requests for specific timed appointments, this cannot be guaranteed. We will not be liable for delays or if it is unable to carry out a repair because a convenient appointment cannot be arranged.

Will there be any charge for the repairs?

It is your responsibility to provide evidence to the Engineer that your product is covered by this guarantee with a proof of purchase. The Manufacturer reserves the right to charge for the reasonable cost of any service call if:

- You cannot provide evidence that your product is covered by this guarantee.
- Where a service call has been made and the engineer finds that there is no fault with your product.
- That your product has not been installed or operated in accordance with the User Instructions Booklet.
- That the fault was caused by something other than faulty materials, defective components or manufacturing defects.
- For missed appointments.

Payment of these costs are due immediately upon the Engineer providing you with an invoice. The Manufacturer reserves the right to terminate the guarantee if you fail to pay the costs for the service call in a timely manner.

If you are a resident of the United Kingdom, this guarantee will be governed by English law and subject to the English Courts, save where you live in another part of the United Kingdom, in which case the law and courts of that location will apply.

If you are resident in the Republic of Ireland, this guarantee will be governed by Irish law and the Irish courts will have jurisdiction.

HOW TO OBTAIN SERVICE

Please keep your purchase receipt or other proof of purchase in a safe place; you will need to have it should the product require attention under guarantee.

It will be useful if you complete the details below, as it will help us assist you when requesting service (the model number is printed on the Instruction Booklet and the serial number is printed on the Rating Label affixed to the appliance). Recording of these details alone will not count as proof of purchase. A valid proof of purchase is required for under guarantee service.

The area around the product must be easily accessible to the Engineer without the need for cabinets or furniture being removed.

It is your responsibility to ensure our Engineers have a clean and safe environment to carry out any repairs.

.....
Model No:

Serial No:

Retailer:

Date of purchase:
.....

For service under guarantee simply telephone the appropriate number below

UK Mainland & Northern Ireland: 0333 207 9920 or

customerservice@support.grundig.co.uk

Republic of Ireland: 01 691 0203

Register your appliance: grundig.co.uk/support/register

Before requesting service please check the troubleshooting guide in the Operating Instructions as a charge may be levied where no fault is found even though your product may still be under guarantee.

Service once the manufacturers guarantee has expired

If you have purchased an extended guarantee please refer to the instructions contained within the extended guarantee agreement document, otherwise please call the appropriate number above where service can be obtained at a charge.

Should you experience any difficulty in obtaining service contact the Grundig Customer Helpline on Tel: 0333 207 9920 or e-mail: customerservice@support.grundig.co.uk

.....
This guarantee is provided by Beko plc. Beko House, 1 Greenhill Crescent, Watford, Herts, WD18 8QU. Beko plc is registered in England and Wales with company registration number 02415578.

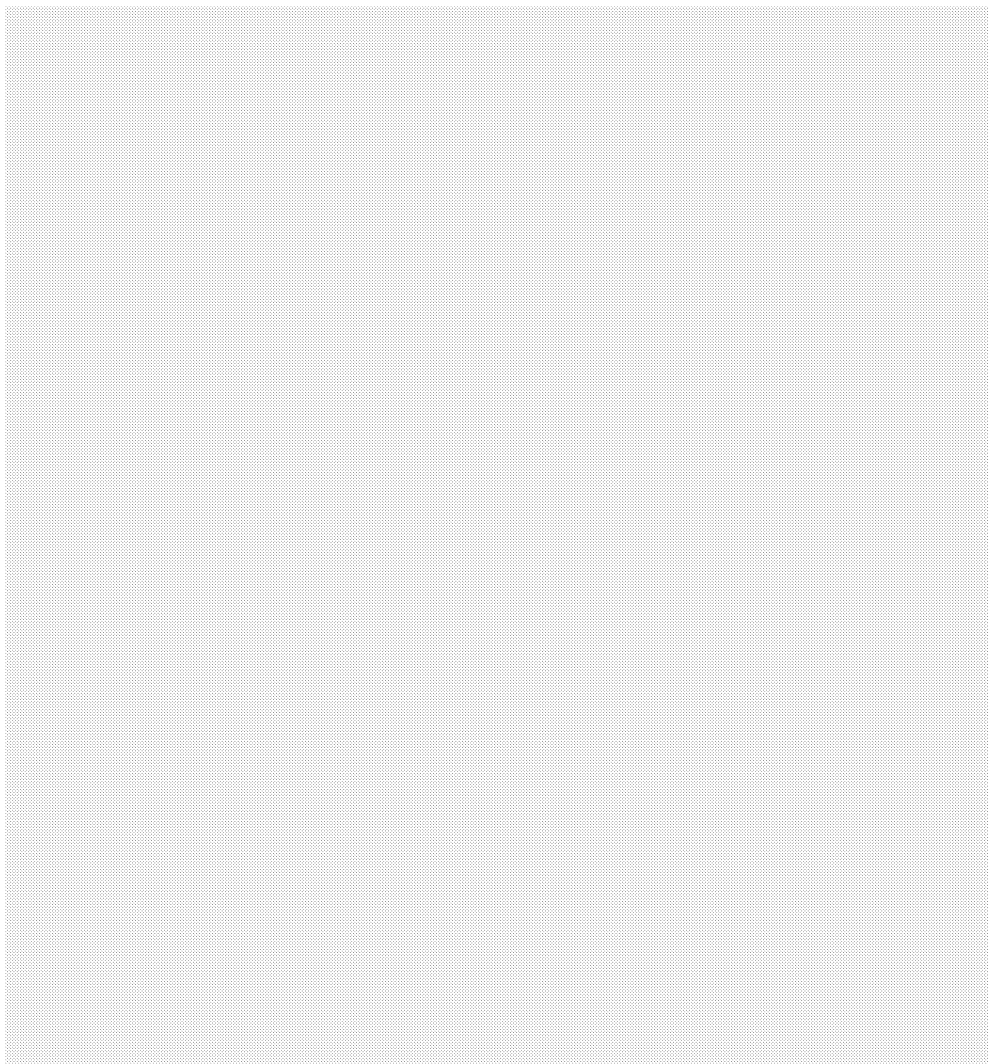

FOR A GOOD REASON

GRUNDIG

www.grundig.com